

0 600 886 002

Issue } 09-11
Stand } 11-08-10

Fig.1/Abb.1

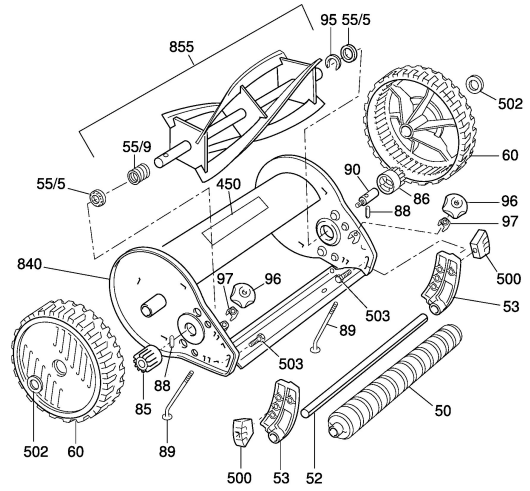
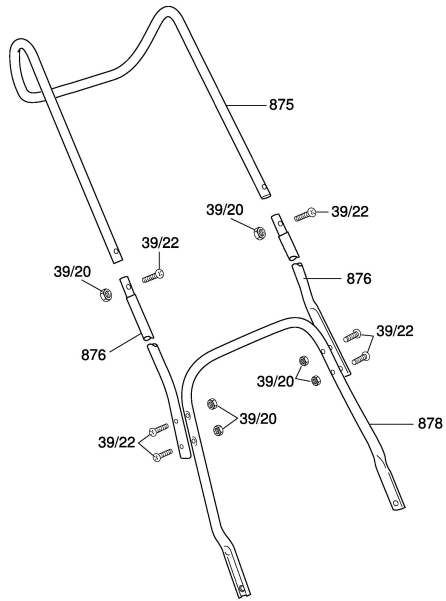

Modifications reserved
Änderungen vorbehalten
Modifications reserves
Salvo modificaciones