

0 601 044 639  
 Issue } 13-10-22  
 Stand }

**Fig./Abb. 1**

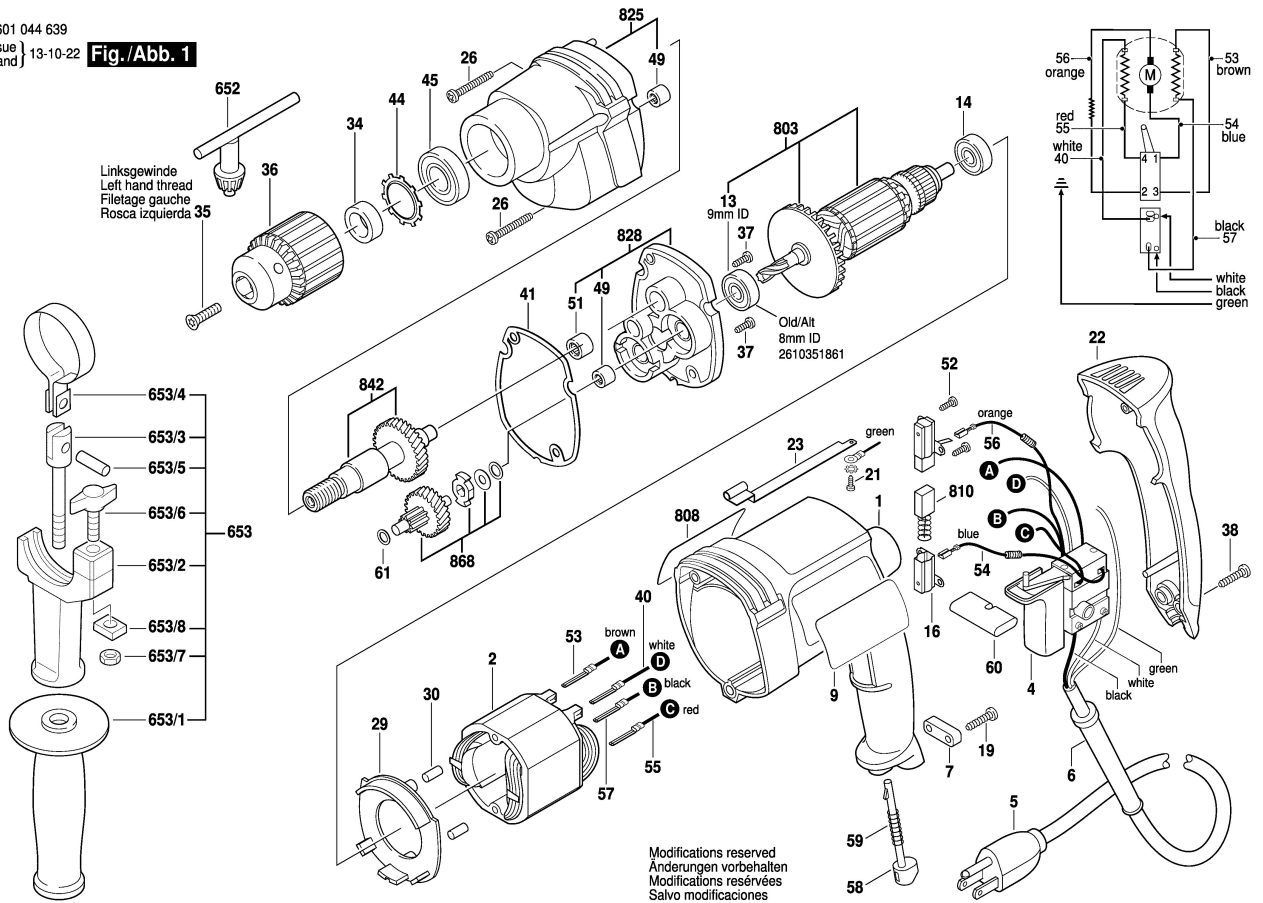

Modifications reserved  
 Änderungen vorbehalten  
 Modifications réservées  
 Salvo modificaciones