

0 601 049 603  
 Issue 14-03-05  
 Stand

**Fig./Abb. 1**

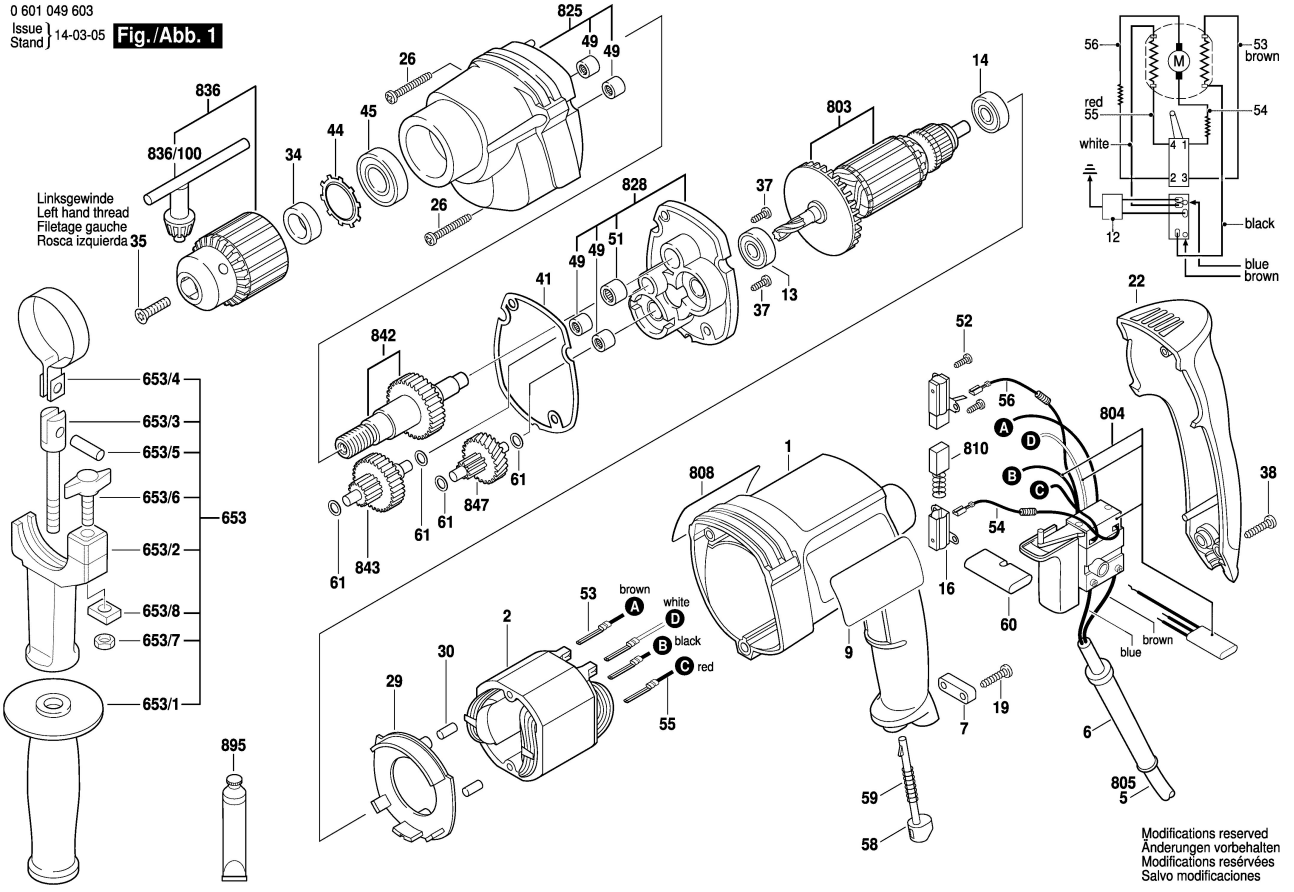

Modifications reserved  
 Änderungen vorbehalten  
 Modifications réservées  
 Salvo modificaciones