

0 601 121 103; 803  
 Issue 14-02-13  
 Stand )

**Fig./Abb. 1**

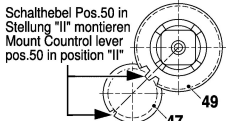
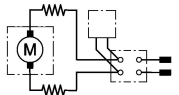

Schalthebel Pos.50 in Stellung "II" montieren  
 Mount Control lever pos.50 in position "II"

Einbauage beachten  
 Check installation position  
 Attention au positionnement  
 Téngase en cuenta la posición de montaje

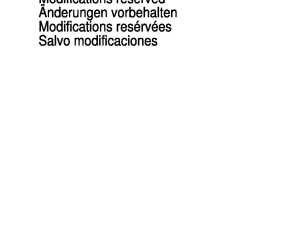
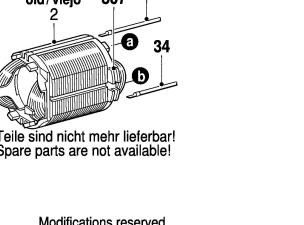
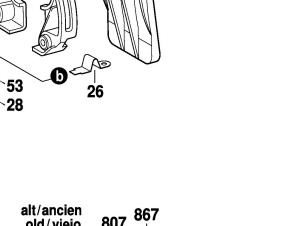
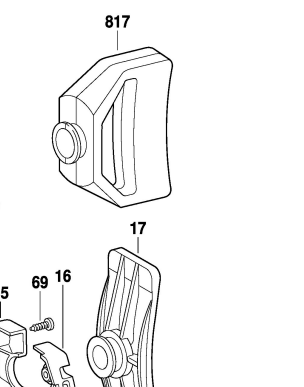
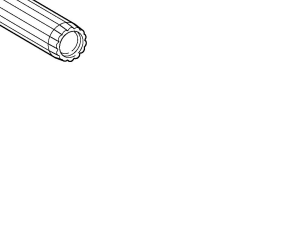
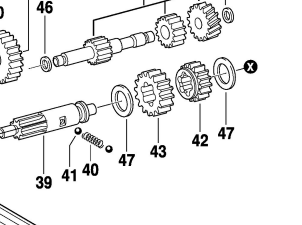
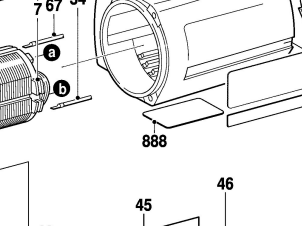
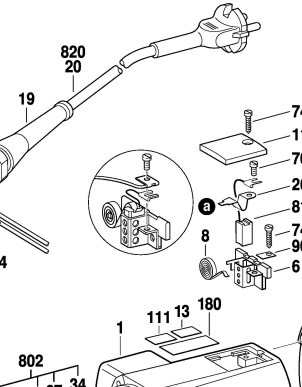
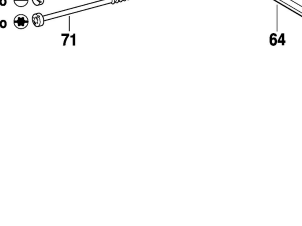
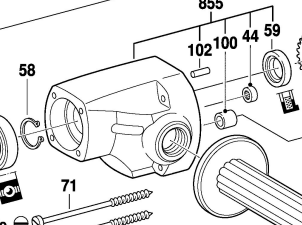
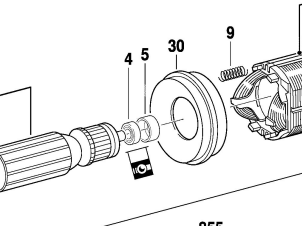
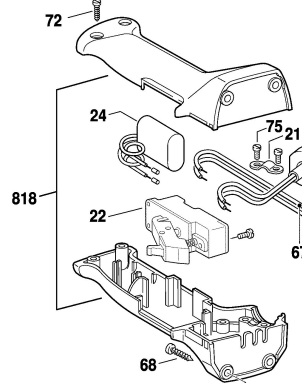
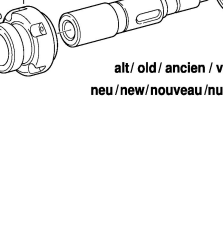
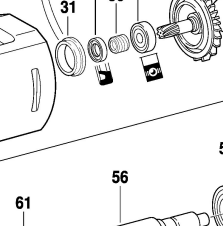
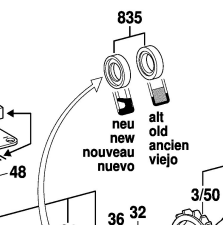
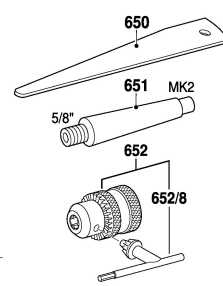
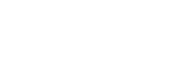
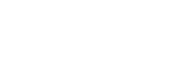
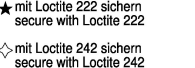
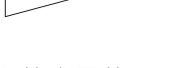
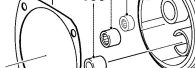
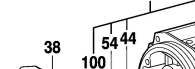

★ mit Loctite 222 sichern  
 secure with Loctite 222

◇ mit Loctite 242 sichern  
 secure with Loctite 242

alt / old / ancien / viejo  
 neu / new / nouveau / nuevo

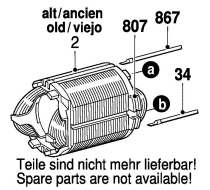

Teile sind nicht mehr lieferbar!  
 Spare parts are not available!

Modifications reserved  
 Änderungen vorbehalten  
 Modifications réservées  
 Salvo modificaciones