

0 601 129 078
Stand 00-10-17
Issue 00-10-23

Fig./Abb. 1

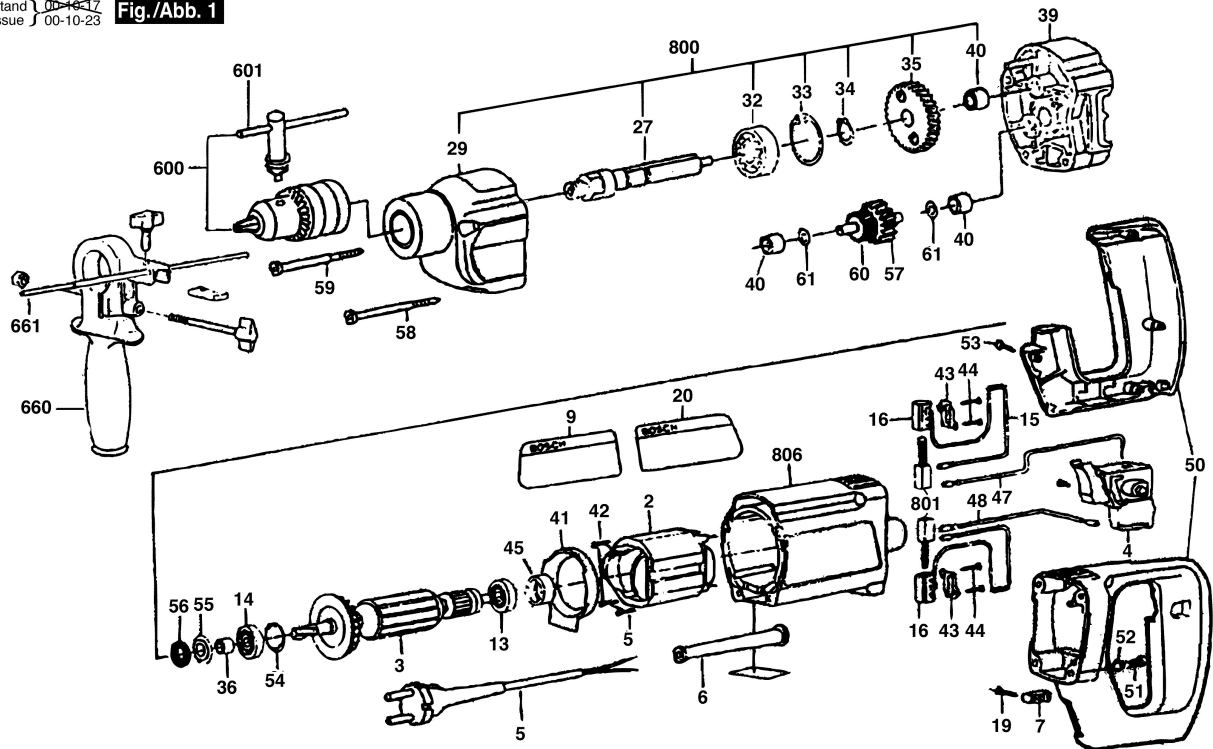

Änderungen vorbehalten
Modifications reserved
Modificacions reserves
Salvo modificaciones