

0 601 130 203
 Stand | 98-09
 Issue | 14-08-14

Fig./Abb. 1

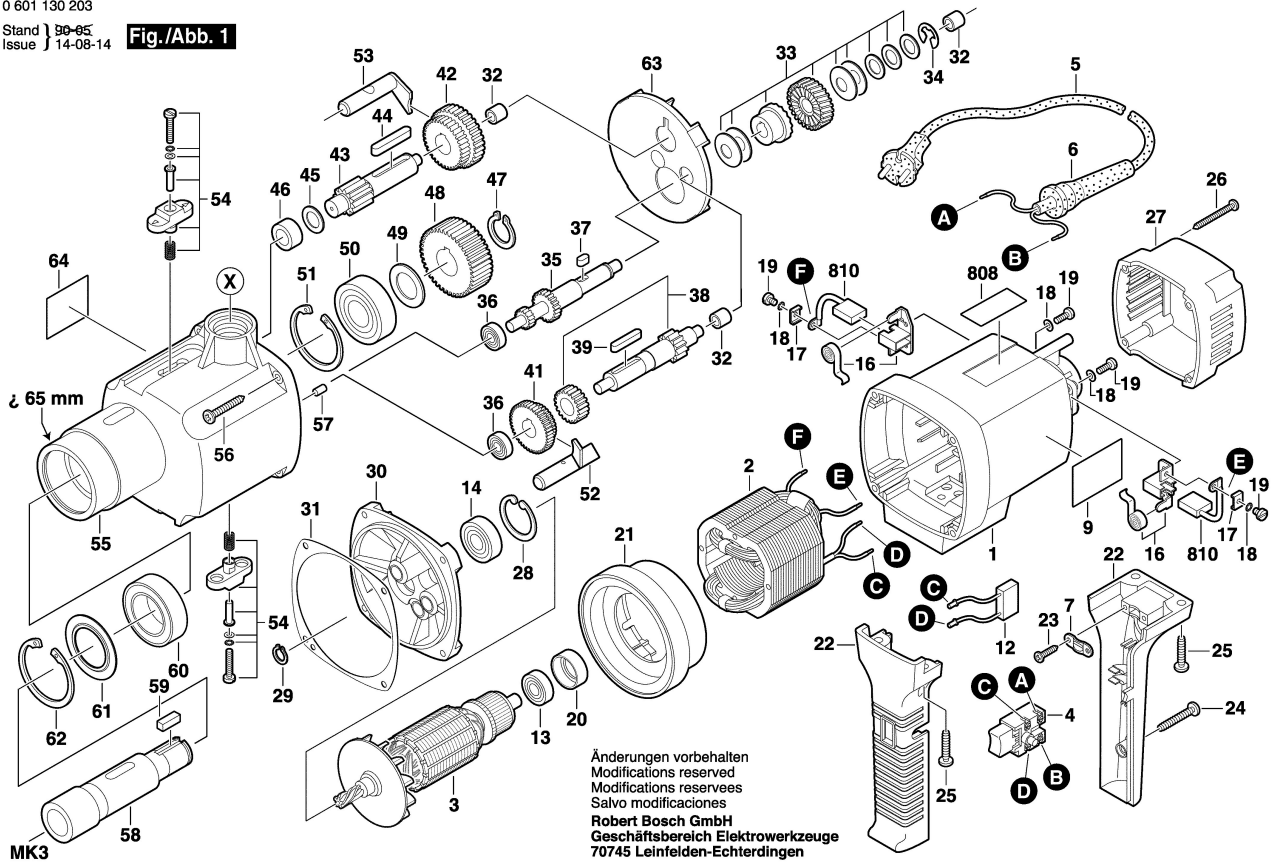

0 601 130 203
 Stand | 98-09
 Issue | 98-10-06

Fig./Abb. 2

