

0 601 135 078
Stand Issue J 01-01-22

Fig./Abb. 1

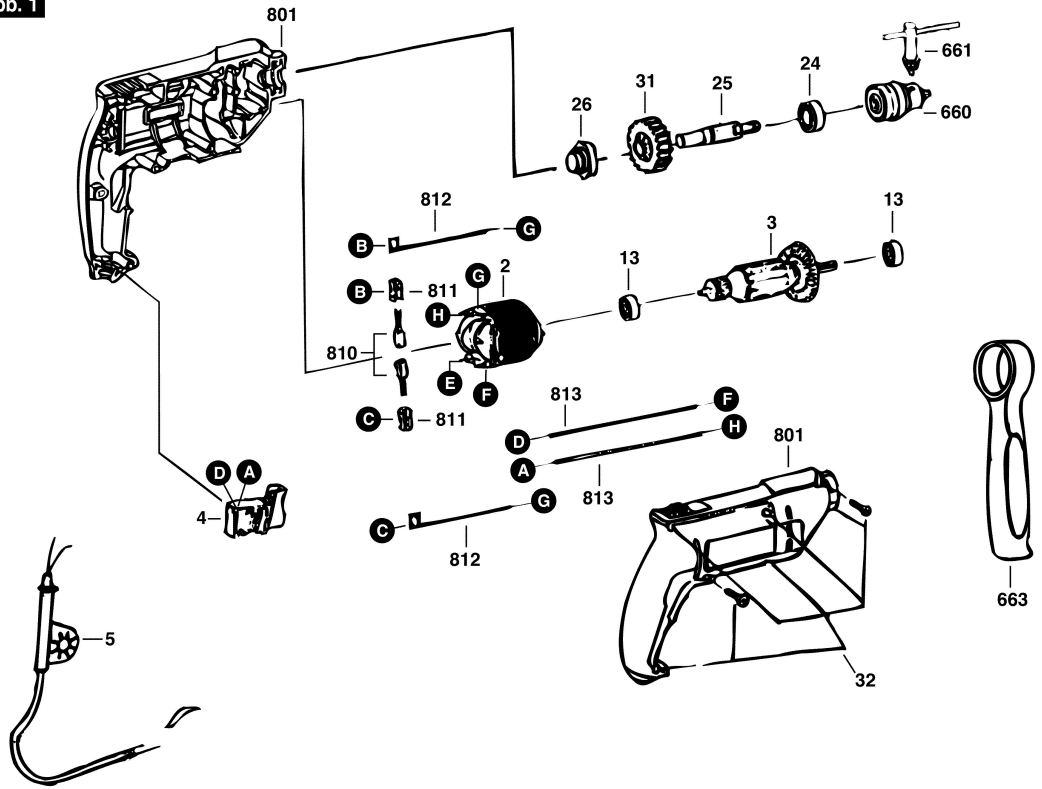

Änderungen vorbehalten
Modifications reserved
Modifications reserves
Salvo modificaciones