

0 601 148 703

Stand } 10-99-22
Issue } 06-03-23 **Fig./Abb. 1**

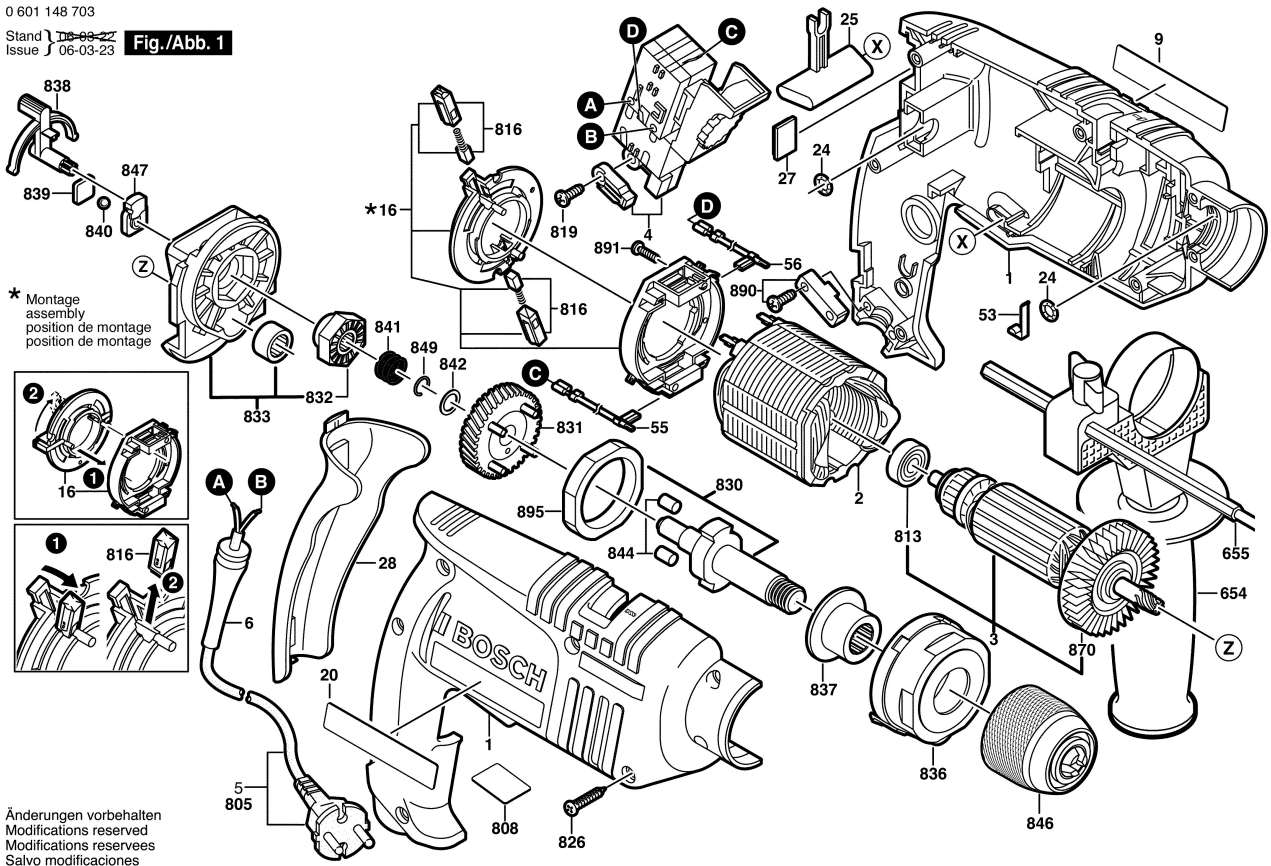

* Montage
assembly
position de montage
position de montage

Änderungen vorbehalten
Modifications reserved
Modifications reserves
Salvo modificaciones