

# Typ 0 601 159 7 . .

Stand | 81-06  
Issue | 94-09

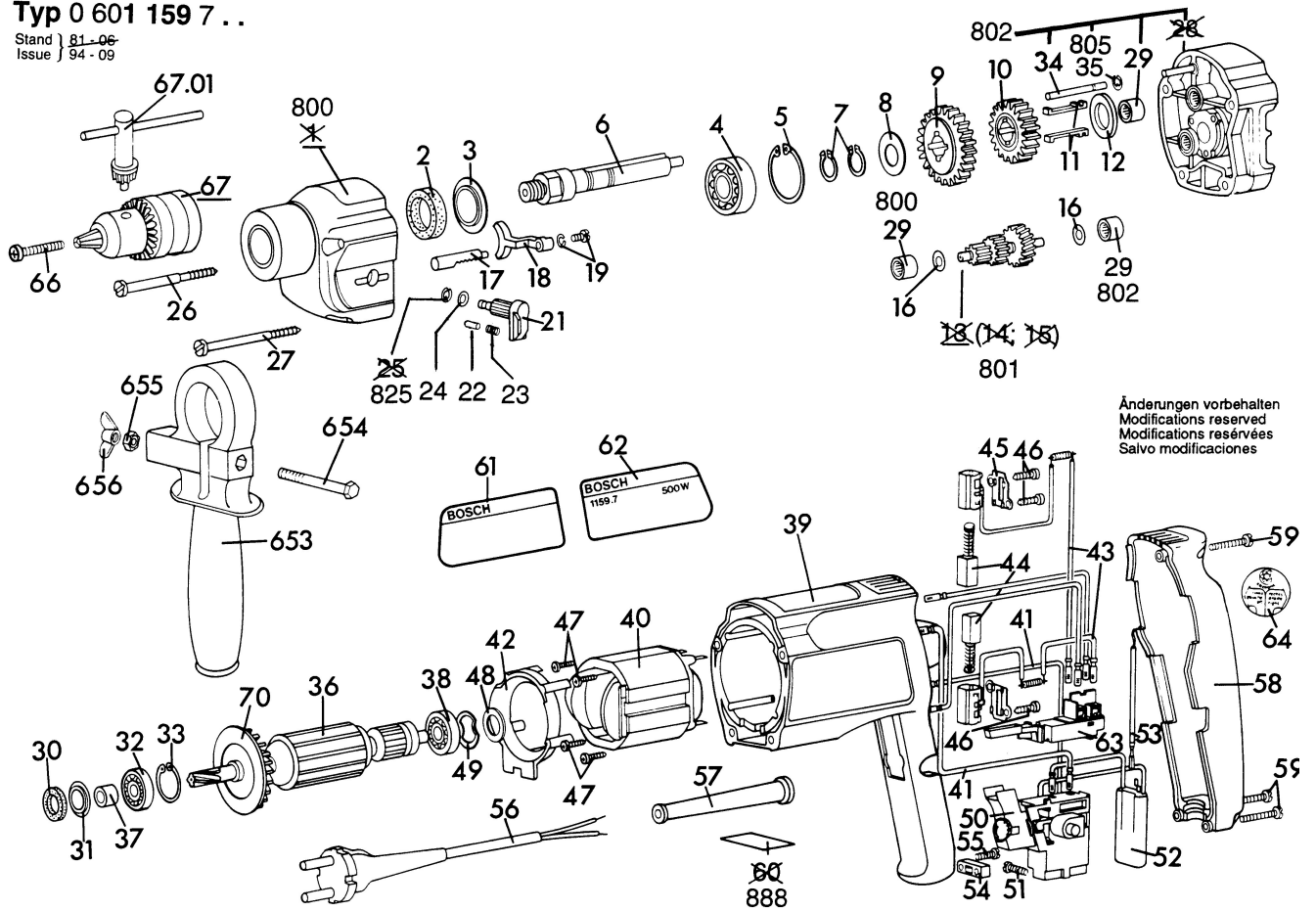

Änderungen vorbehalten  
Modifications reserved  
Modifications réservées  
Salvo modificaciones