

0 601 163 078

Stand }
Issue }

00-11-15 **Fig./Abb. 1**

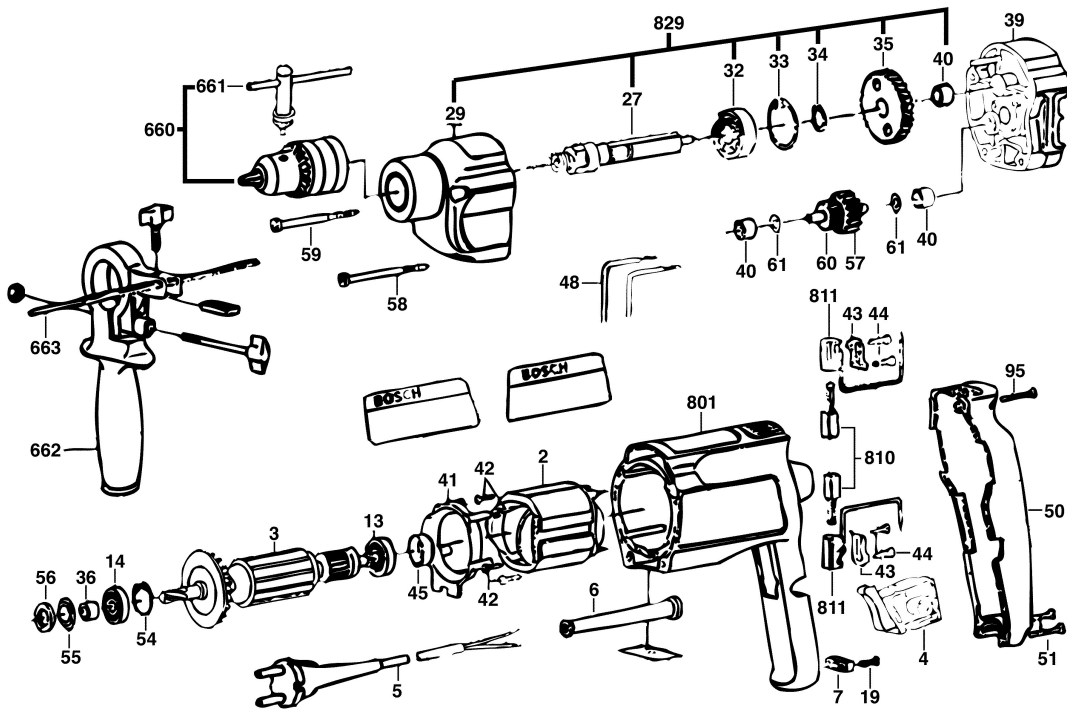

Änderungen vorbehalten
Modifications reserved
Modificaciones reservadas
Salvo modificaciones