

0 601 188 603
Issue / Stand } 14-02-03

Fig./Abb. 1

Änderungen vorbehalten
Modifications reserved
Modifications réservées
Salvo modificaciones

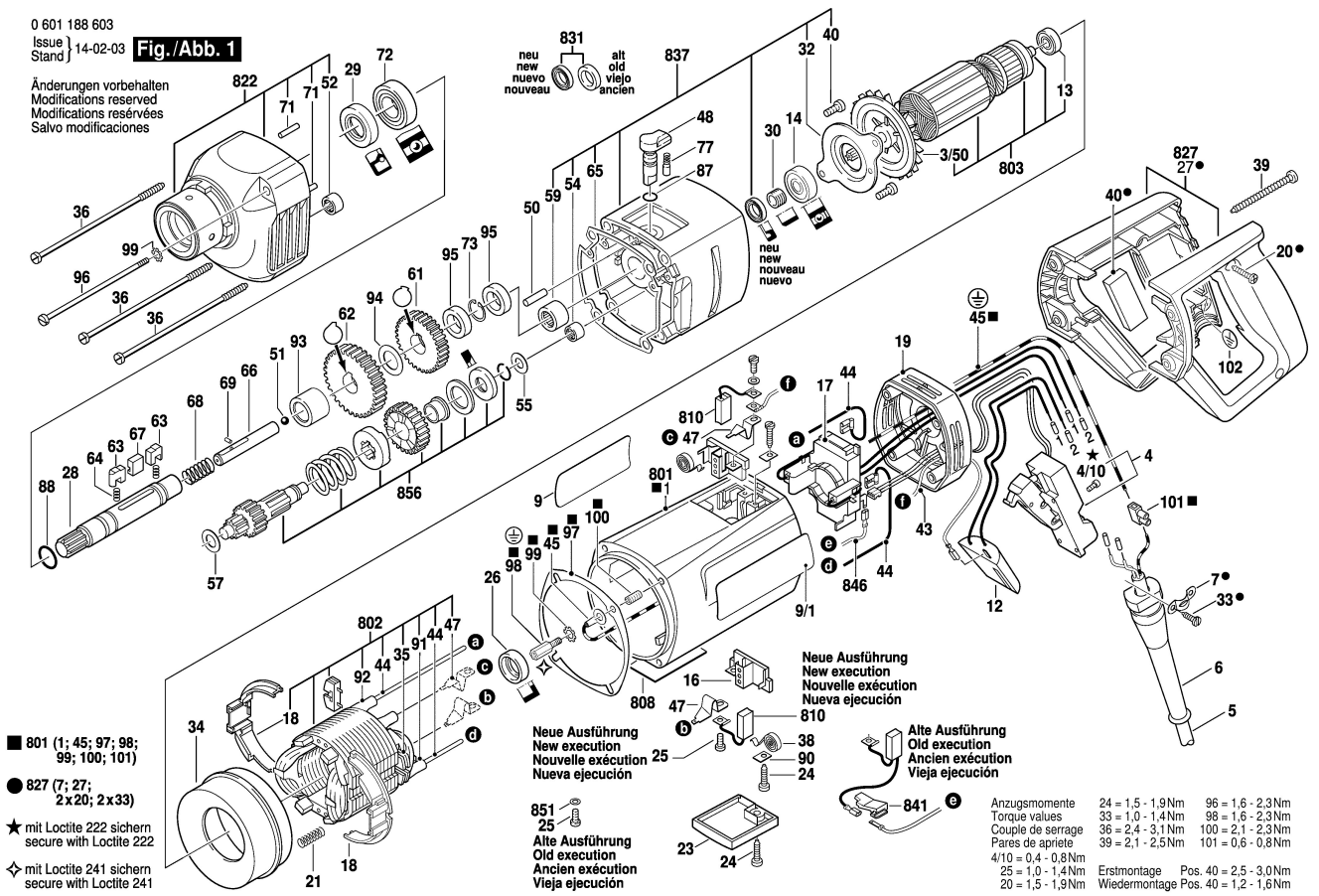

0 601 188 603
Issue / Stand } 14-02-03

Fig./Abb. 2

Änderungen vorbehalten
Modifications reserved
Modifications réservées
Salvo modificaciones

