

0 601 375 006  
 Stand | 08-01  
 Issue | 14-07-22

**Fig. /Abb. 1**

**Gerad - Verzahnung**

● Vor Demontage des Ankers  
 Kohlebürsten 5mm zurückziehen !  
 Before the armature is removed the carbon brushes  
 must be withdrawn by at least 5mm !

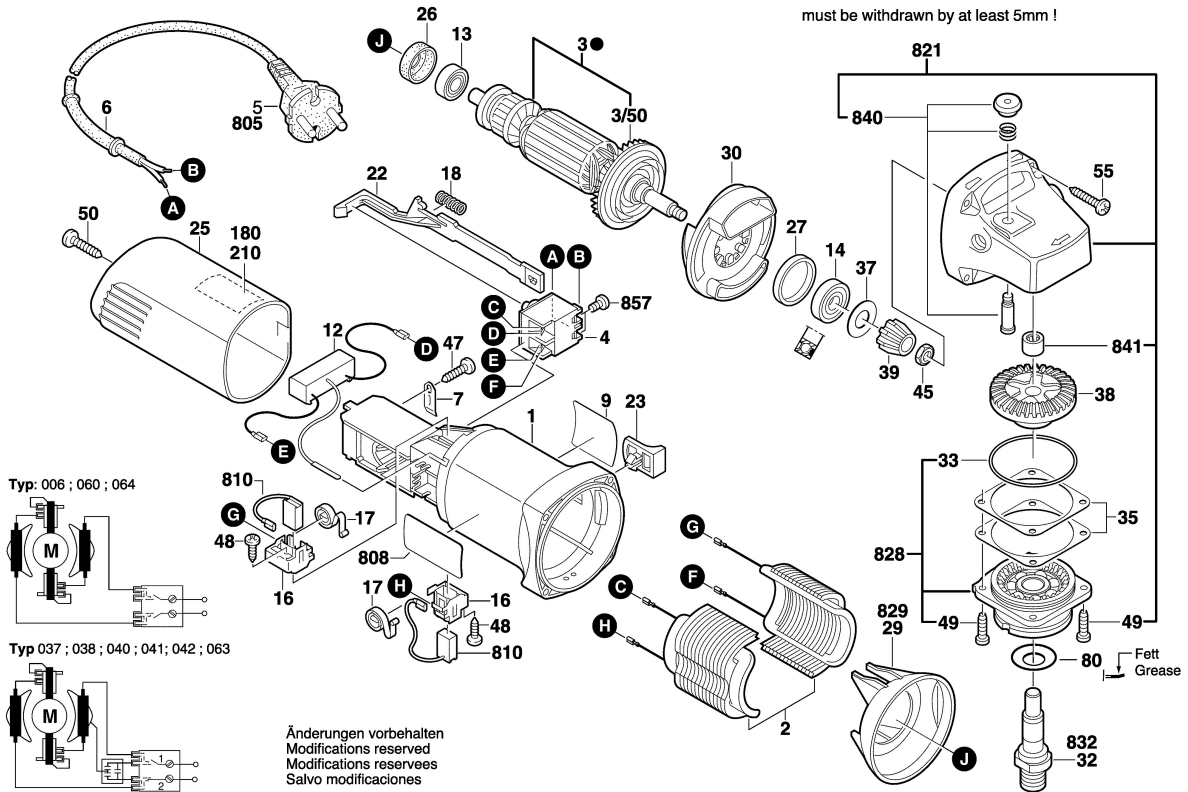

Änderungen vorbehalten  
 Modifications reserved  
 Modifications reserves  
 Salvo modificaciones

0 601 375 006  
 Stand | 03-07  
 Issue | 07-08-09

**Fig. /Abb. 2**

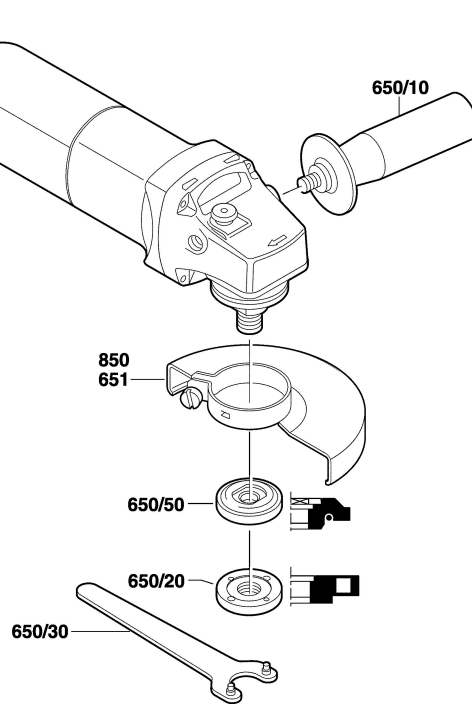

Änderungen vorbehalten  
 Modifications reserved  
 Modifications reserves  
 Salvo modificaciones