

0 601 405 734

Stand Issue J 00-08-17

Fig./Abb. 1

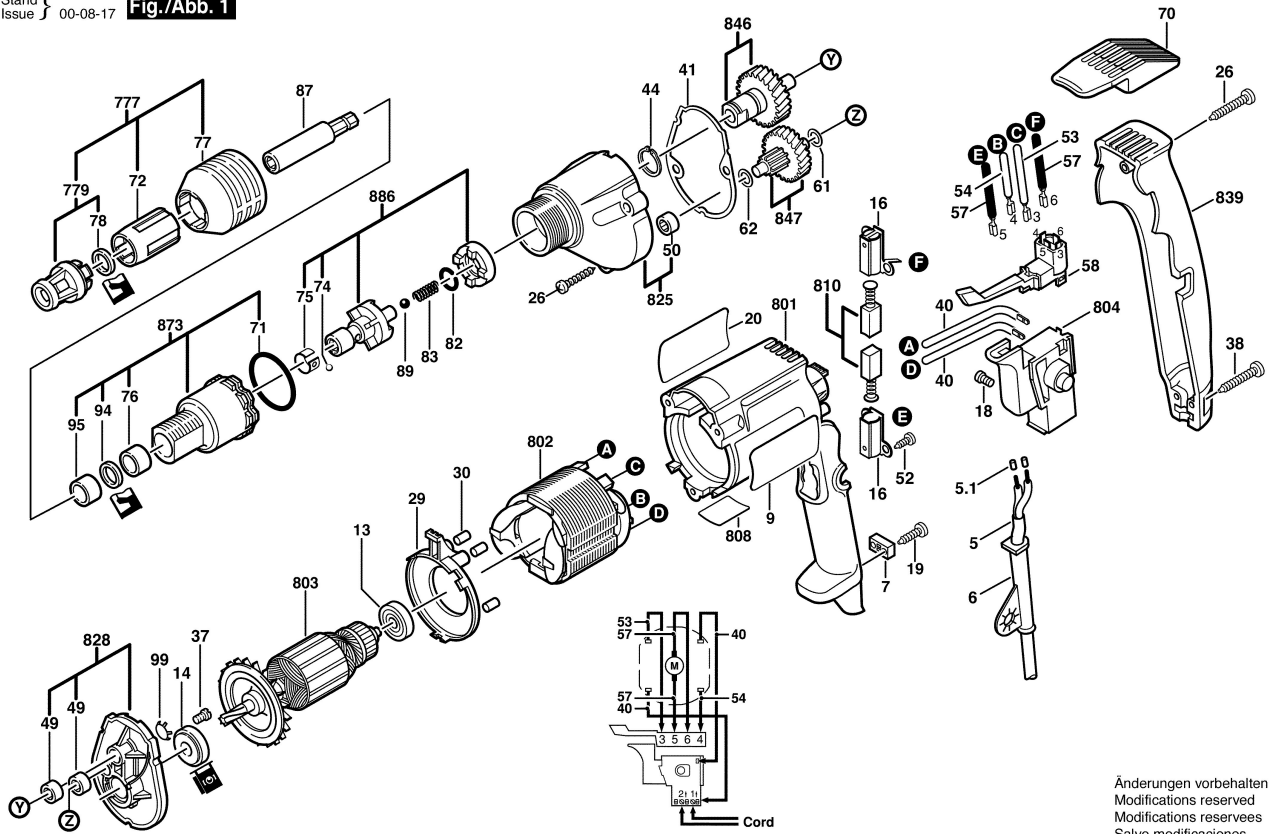

Änderungen vorbehalten
Modifications reserved
Modifications reserves
Salvo modificaciones