

0 601 594 005
Stand 12-92
Issue 09-10-22

Fig./Abb. 1

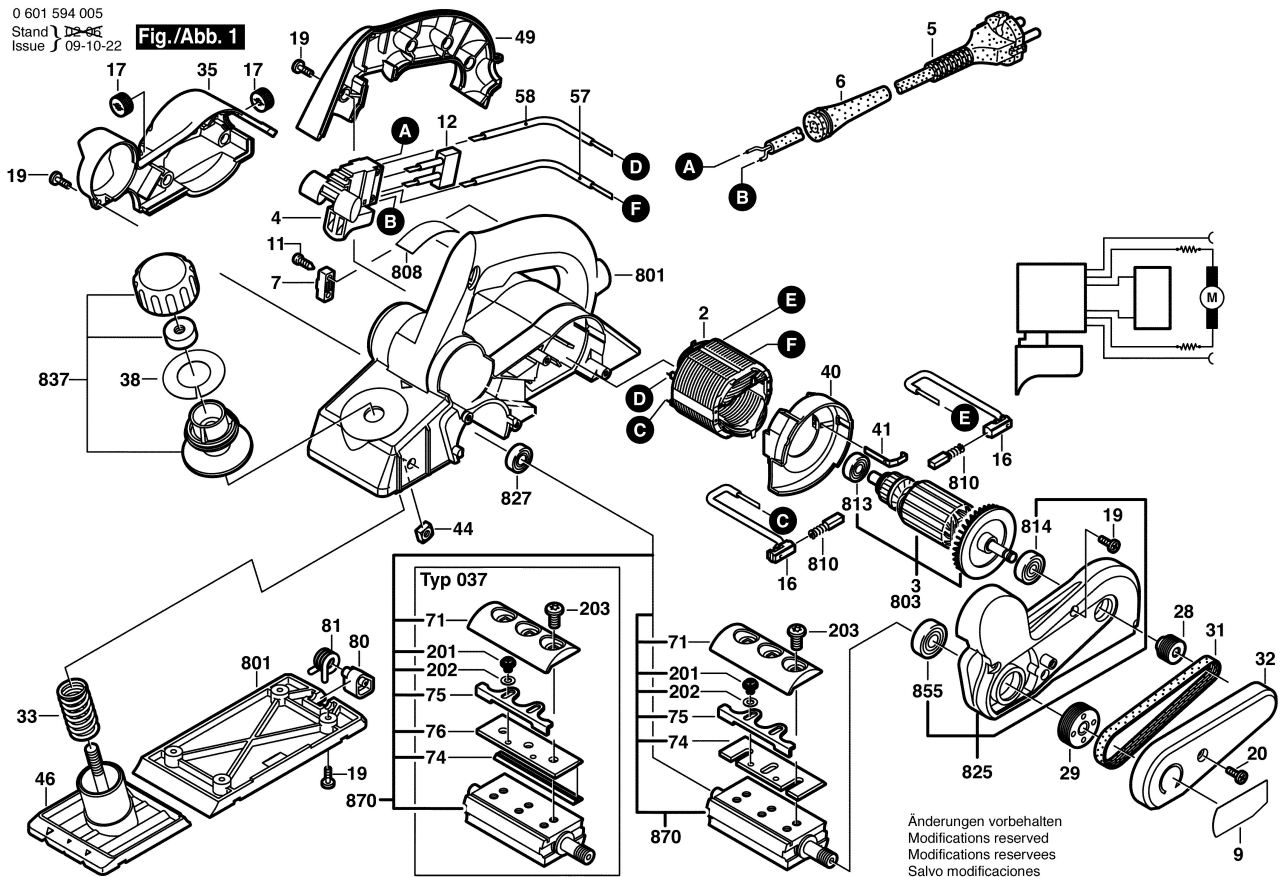

Änderungen vorbehalten
Modifications reserved
Modifications reserves
Salvo modificaciones