

0 601 597 703
 Stand 1 07-06
 Issue J 09-10-23

Abb./Fig. 1

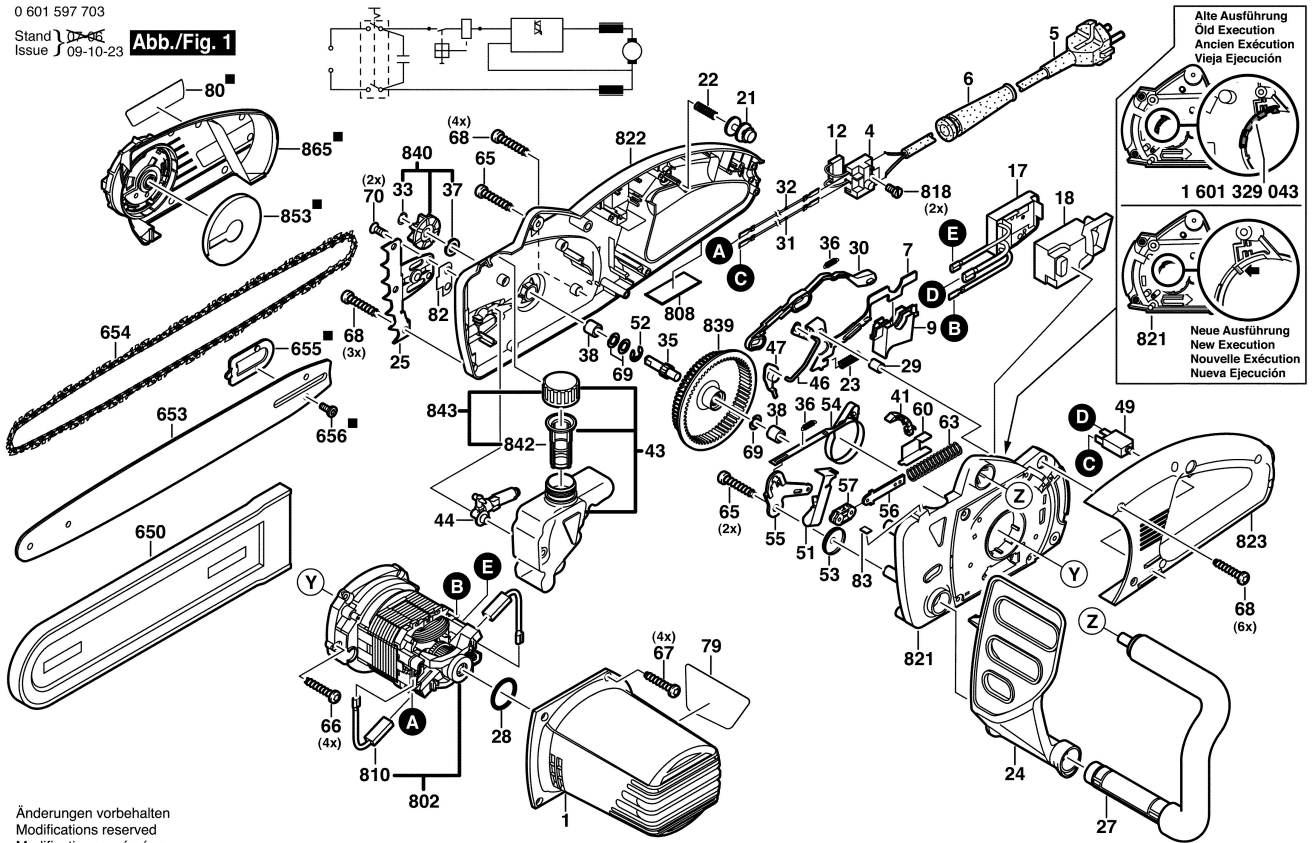

Änderungen vorbehalten
 Modifications reserved
 Modifications réservées
 Salvo modificaciones