

3 601 H60 311

Stand 09-01
Issue 09-07-08

Fig./Abb. 1

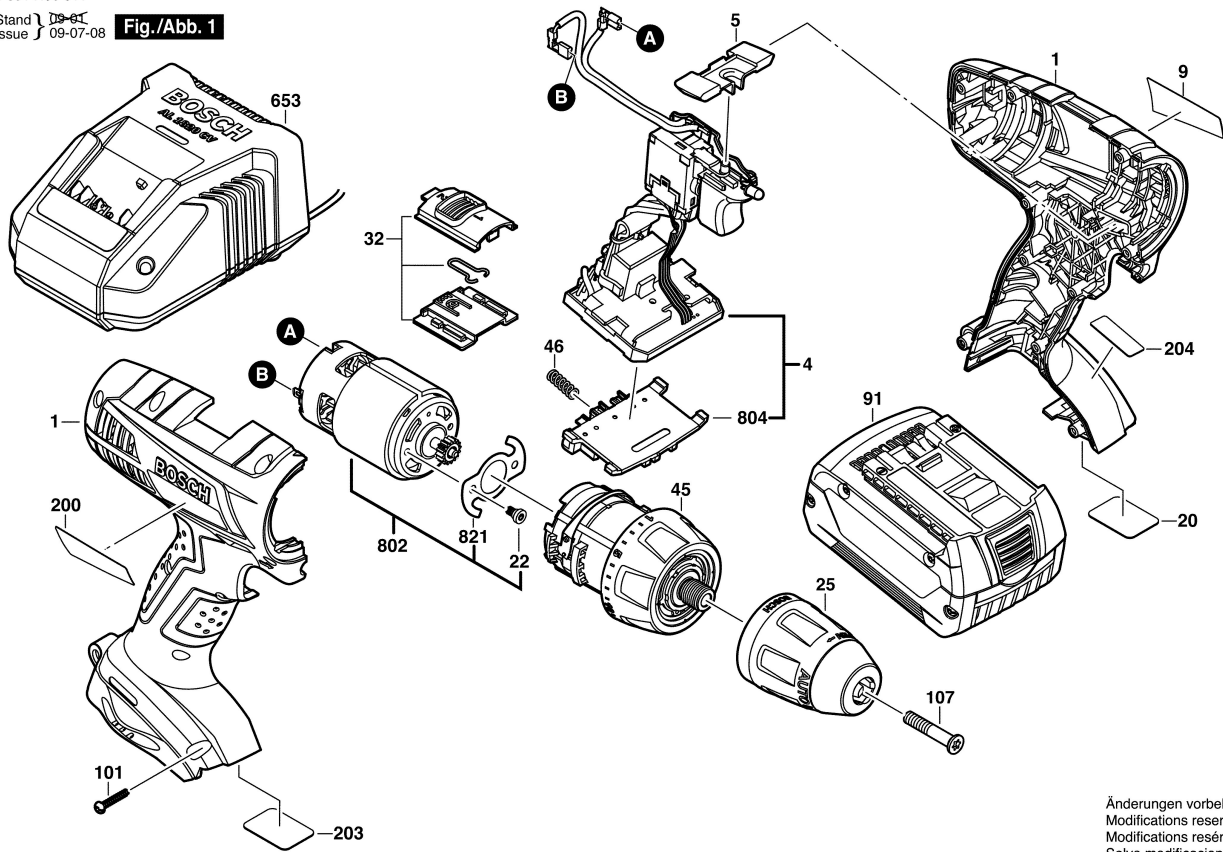

Änderungen vorbehalten
Modifications reserved
Modifications réservées
Salvo modificaciones