

3 601 H60 411

Stand 08-11
Issue 09-01-21

Fig./Abb. 1

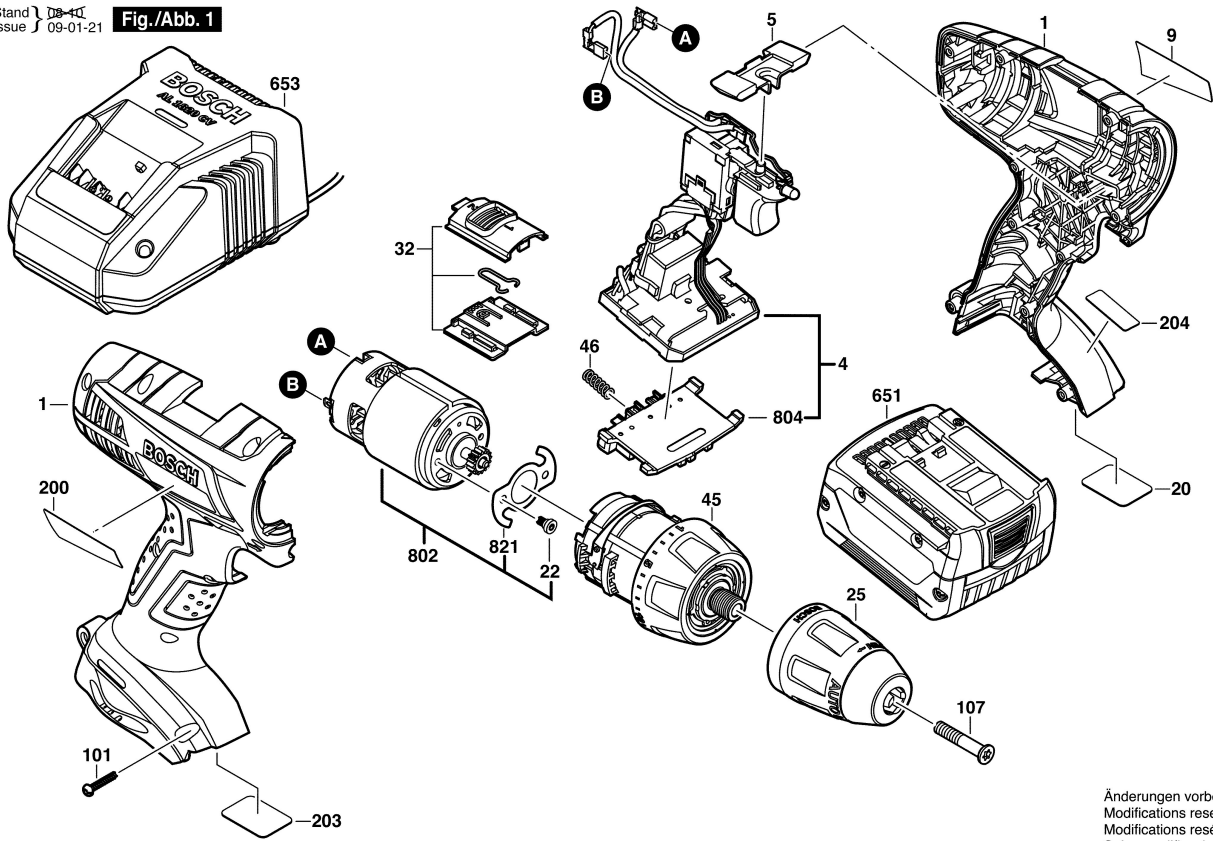

Änderungen vorbehalten
Modifications reserved
Modifications réservées
Salvo modificaciones