

0 601 912 420
Stand 15-41
Issue 07-02-01

Fig./Abb. 1

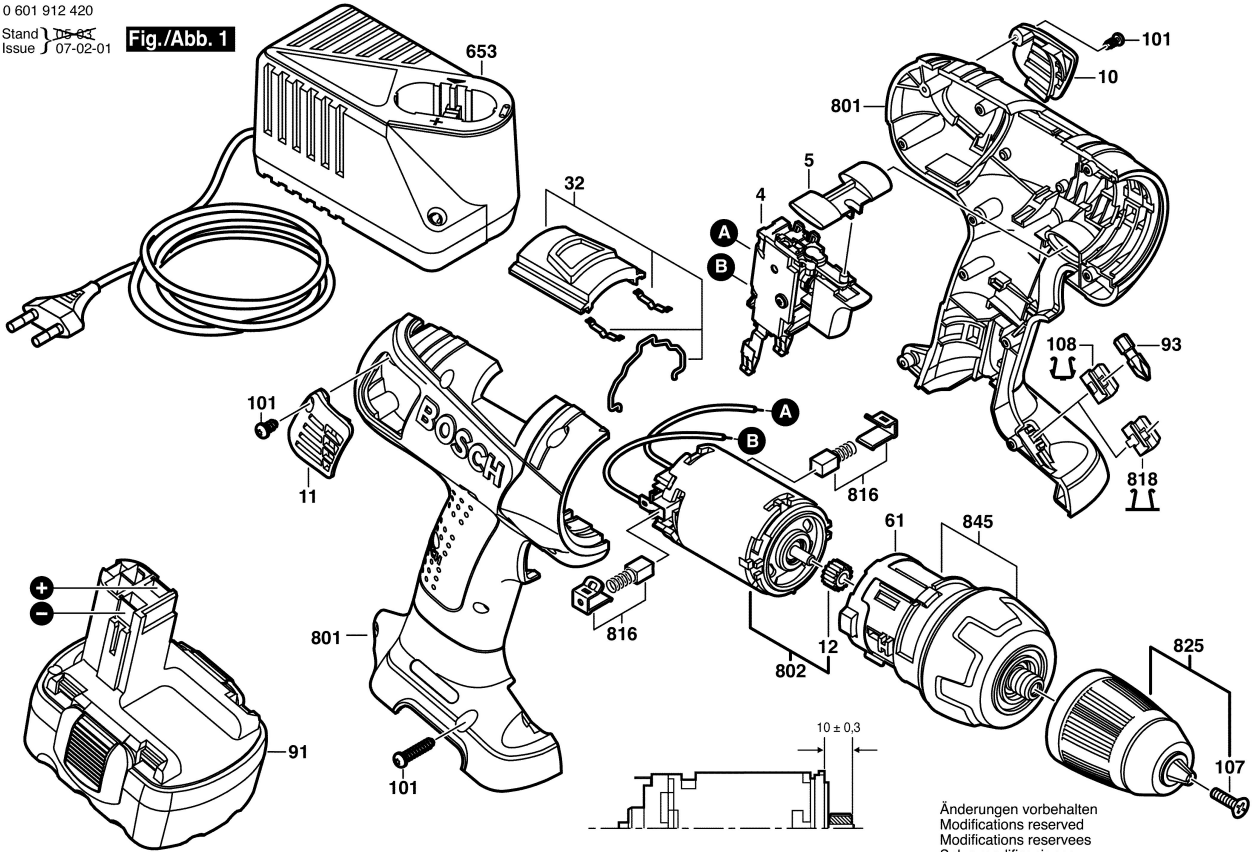

Änderungen vorbehalten
Modifications reserved
Modifications reserves
Salvo modificaciones