

0 601 912 520  
Stand 15-01  
Issue 07-02-01

Fig./Abb. 1

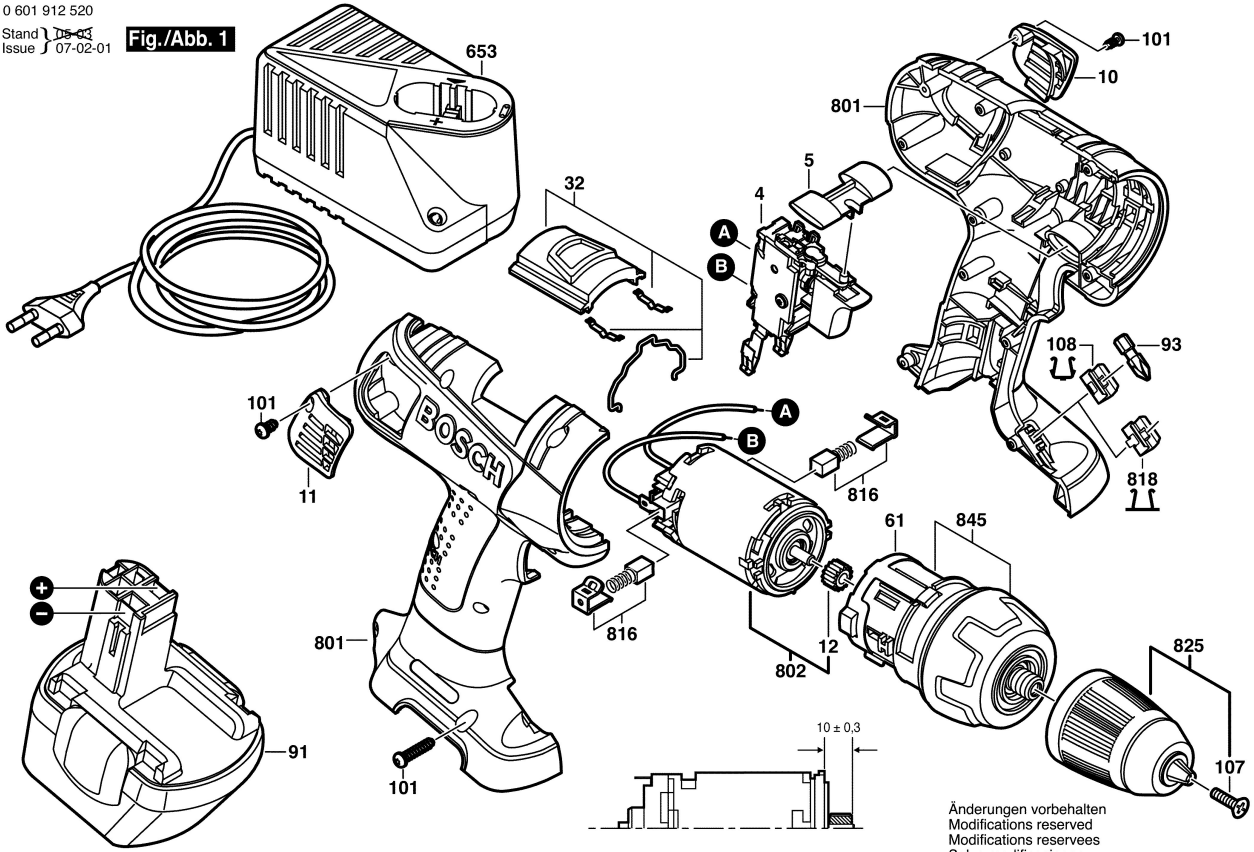

Änderungen vorbehalten  
Modifications reserved  
Modifications reserves  
Salvo modificaciones