

0 601 913 420
Stand 1 05-01
Issue J 07-02-01

Fig./Abb. 1

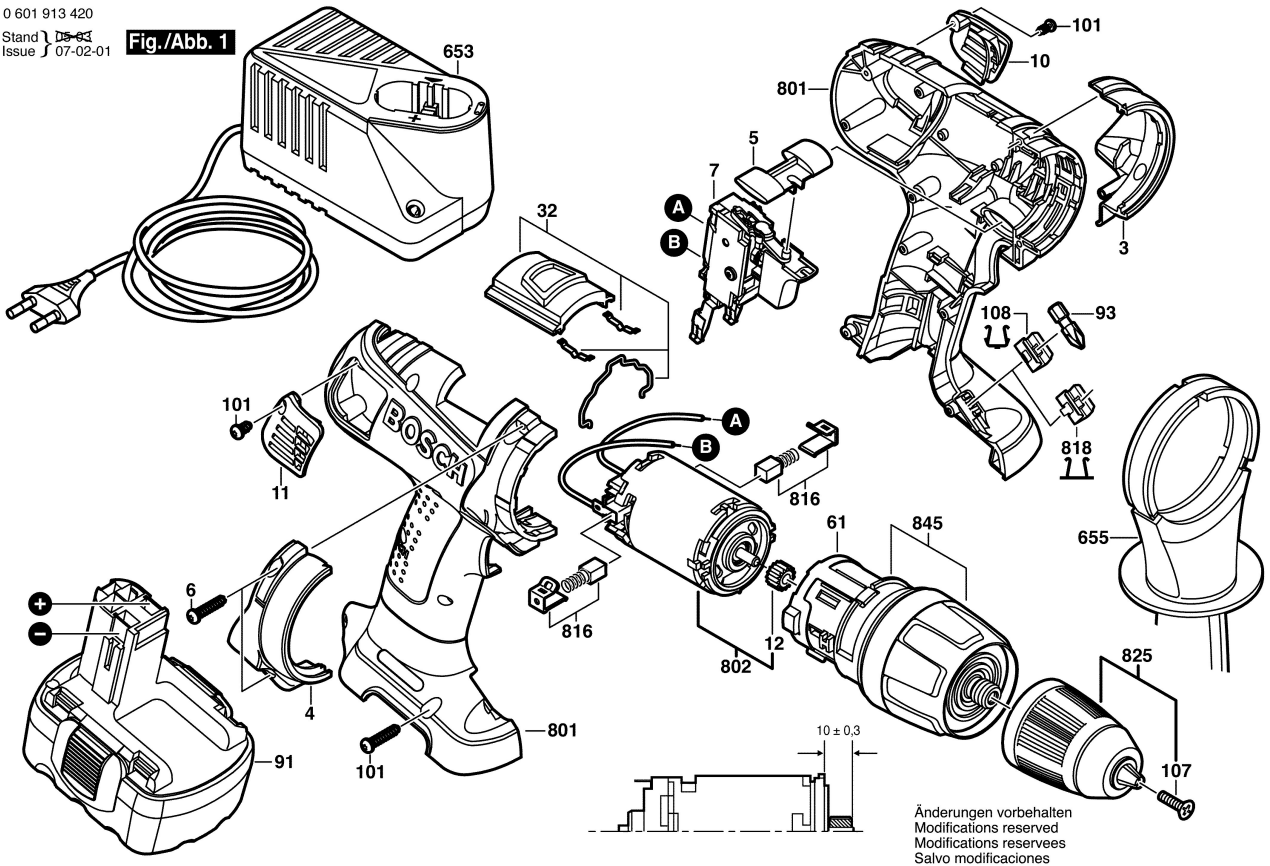

Änderungen vorbehalten
Modifications reserved
Modifications reserves
Salvo modificaciones