

0 601 946 603

Stand 11-03-14
Issue 01-03-14 **Fig./Abb. 1**

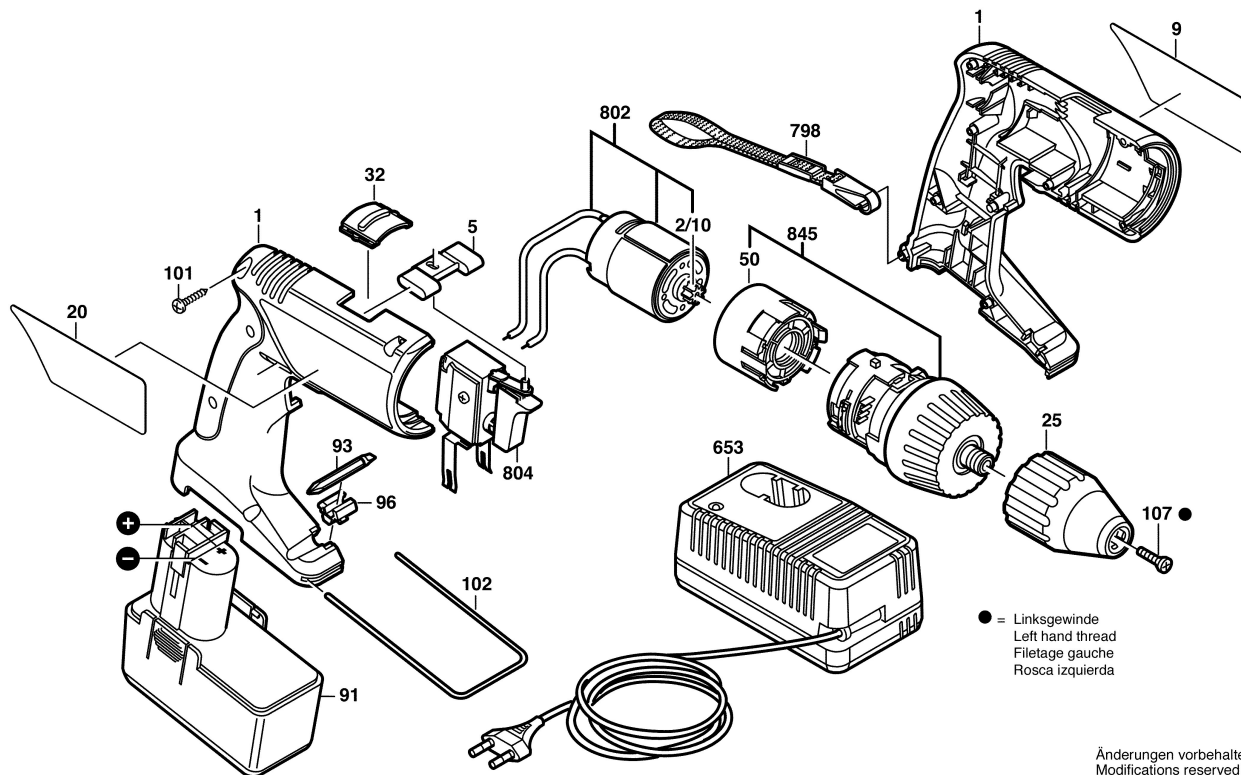

Änderungen vorbehalten
Modifications reserved
Modifications reserves
Salvo modificaciones