

0 601 948 603

Stand 1-11  
Issue 01-03-21

**Fig./Abb. 1**

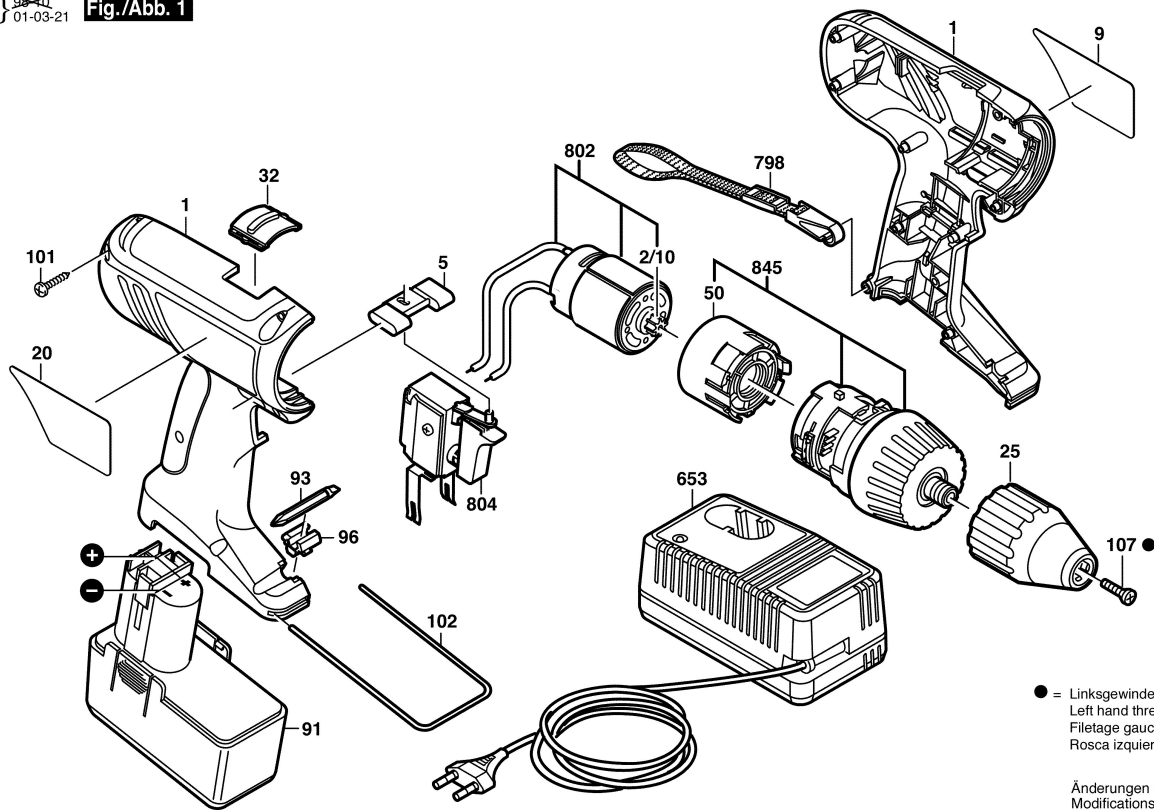

● = Linksgewinde  
Left hand thread  
Filetage gauche  
Rosca izquierda

Änderungen vorbehalten  
Modifications reserved  
Modifications reserves  
Salvo modificaciones