

0 601 951 320

Stand 1-19
Issue 01-03-19

Fig./Abb. 1

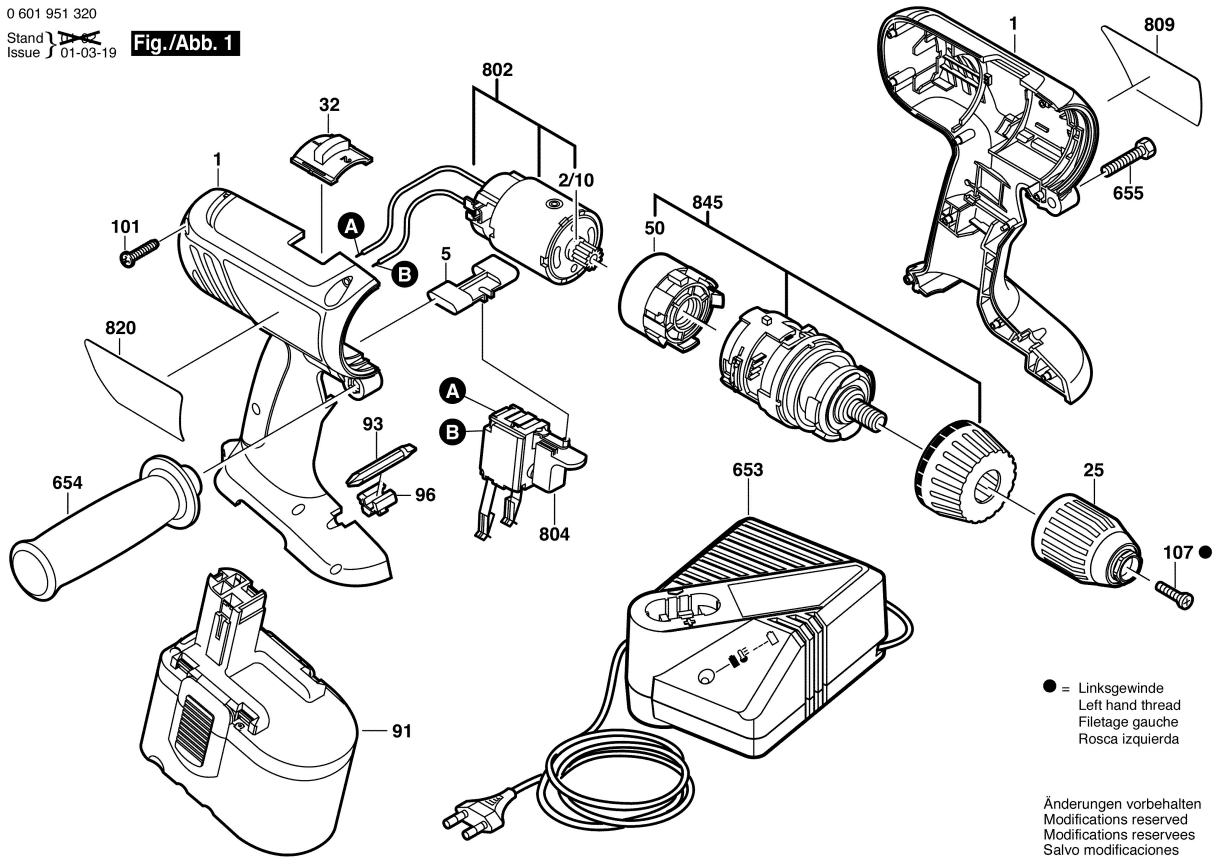

● = Linksgewinde
Left hand thread
Filetage gauche
Rosca izquierda

Änderungen vorbehalten
Modifications reserved
Modifications reserves
Salvo modificaciones