

0 601 952 420
Stand 11-87
Issue 01-10-24

Fig./Abb. 1

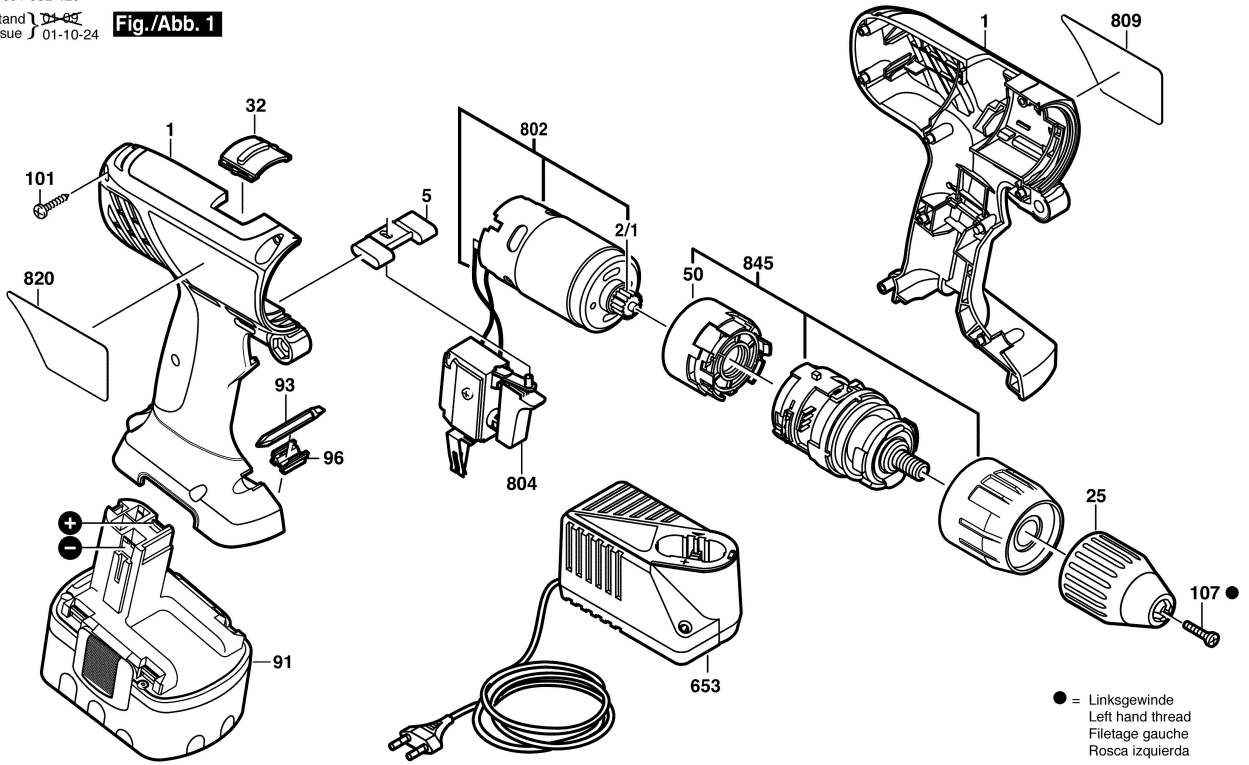

Änderungen vorbehalten
Modifications reserved
Modificacions reserves
Salvo modificaciones