

0 603 114 078

Issue } 30-05-01
Stand }

Fig.1/Abb.1

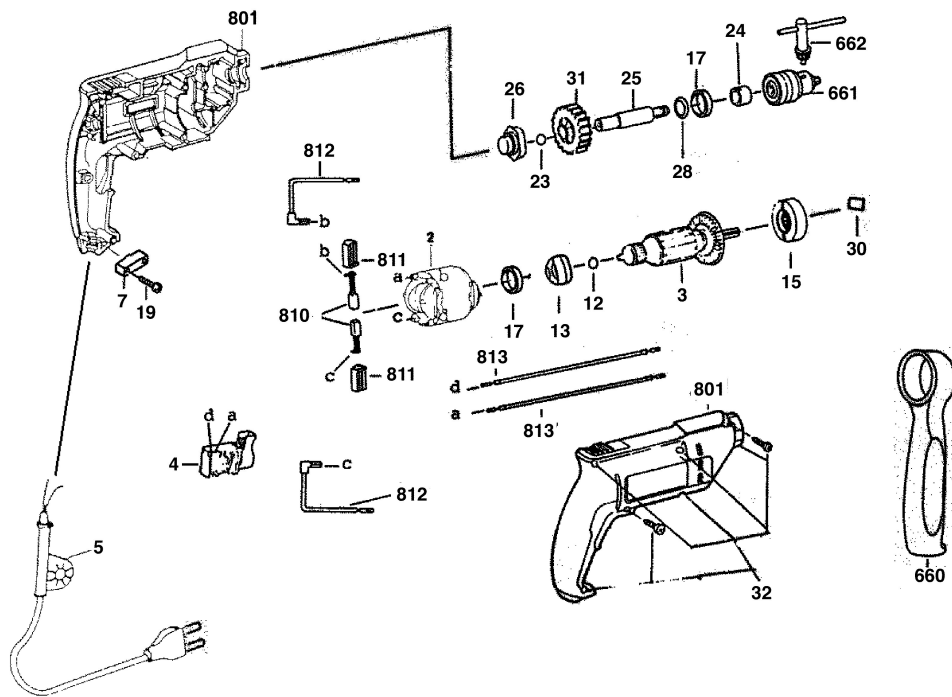

Änderungen vorbehalten
Modifications reserved
Modifications reserves
Salvo modificaciones