

0 603 114 575

Issue }
Stand } 30-05-01

Fig.1/Abb.1

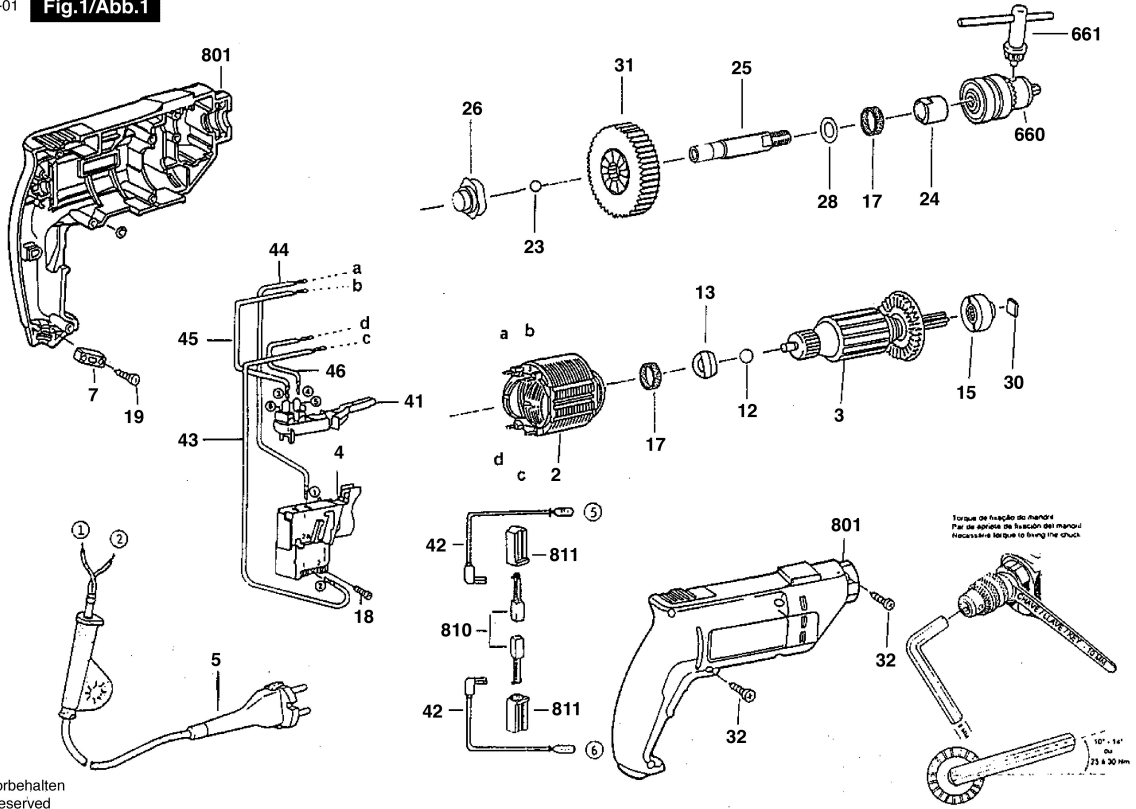

Änderungen vorbehalten
Modifications reserved
Modifications reserves
Salvo modificaciones