

0 603 330 003
Stand 1 05-10
Issue J 09-11-30

Fig./Abb. 1

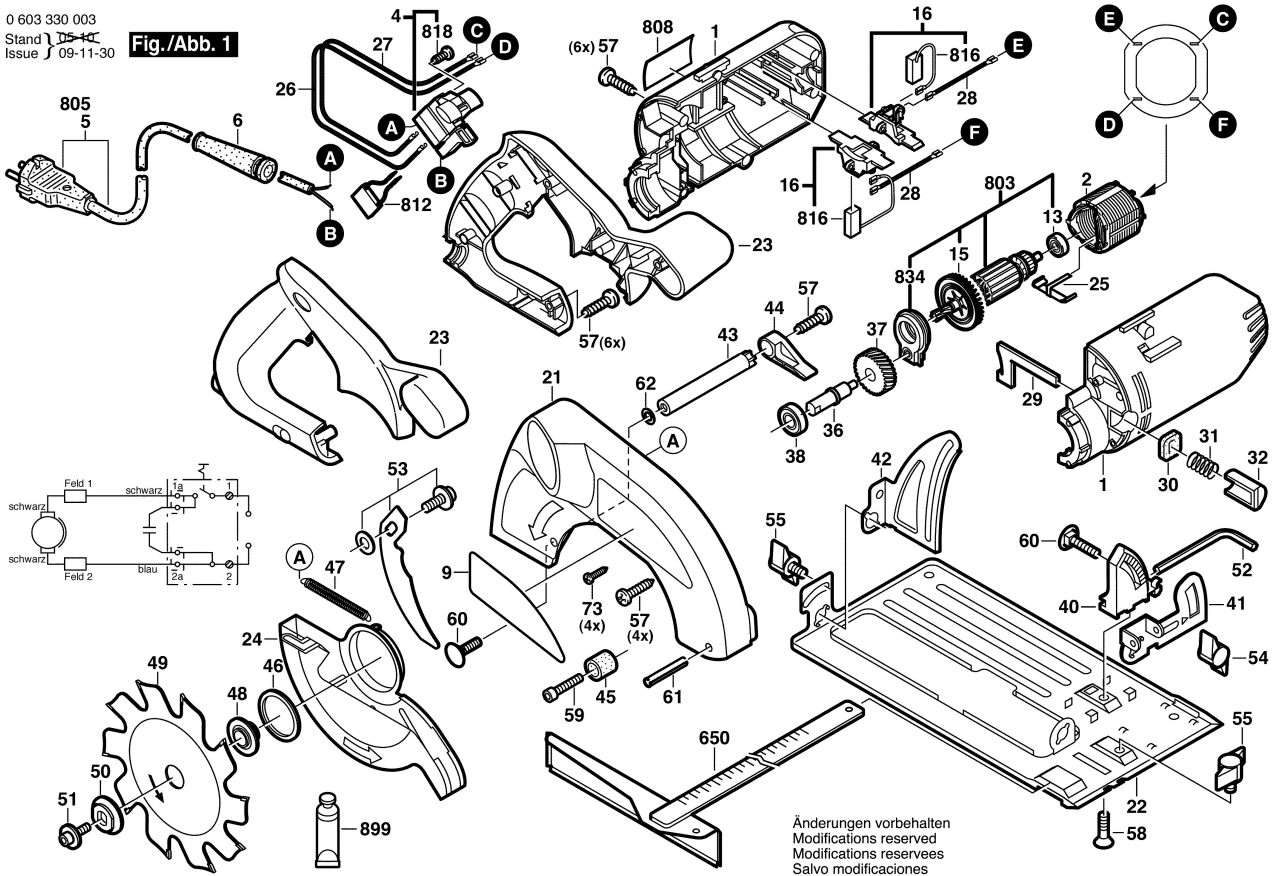

Änderungen vorbehalten
Modifications reserved
Modifications reserves
Salvo modificaciones