

0 603 943 520
Stand | 03-03-24
Issue | 03-03-24

Fig./Abb. 1

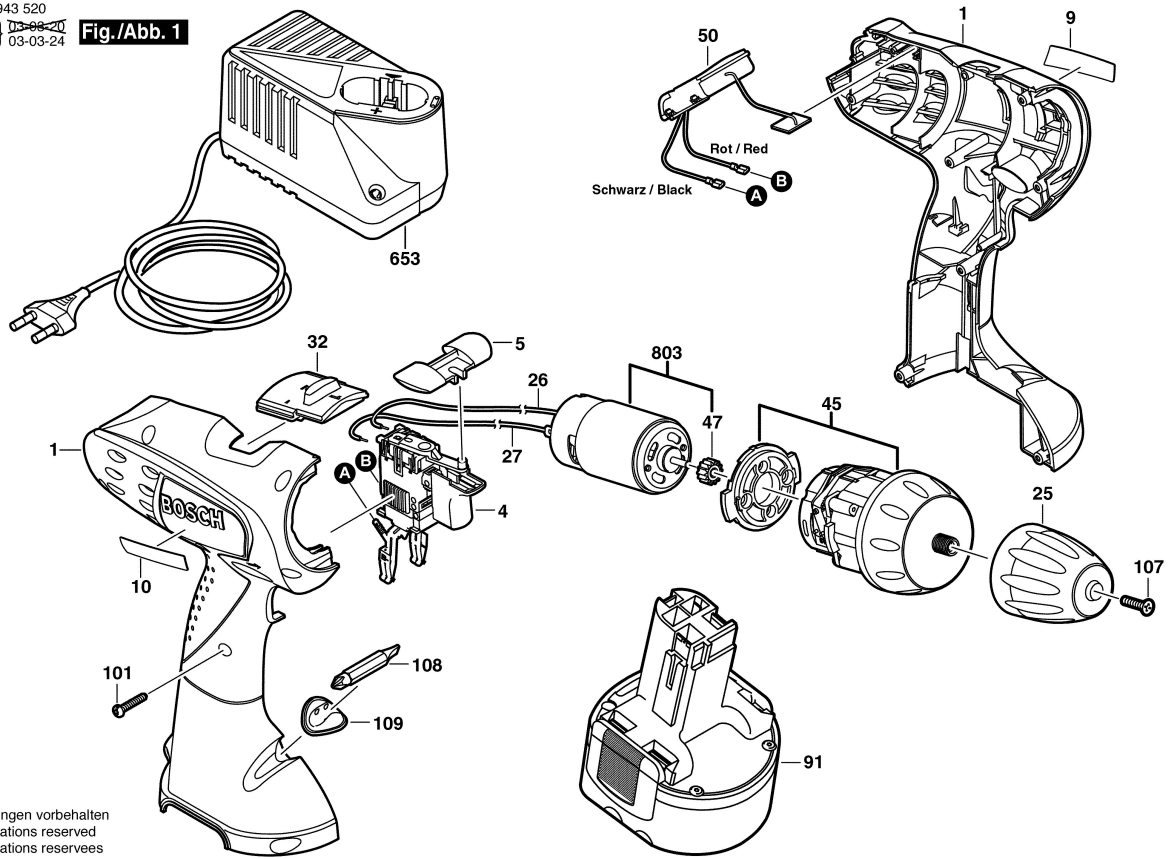

Änderungen vorbehalten
Modifications reserved
Modificaciones reservadas
Salvo modificaciones