

0 603 946 503

Stand } 1-83
Issue } 01-04-03

Fig./Abb. 1

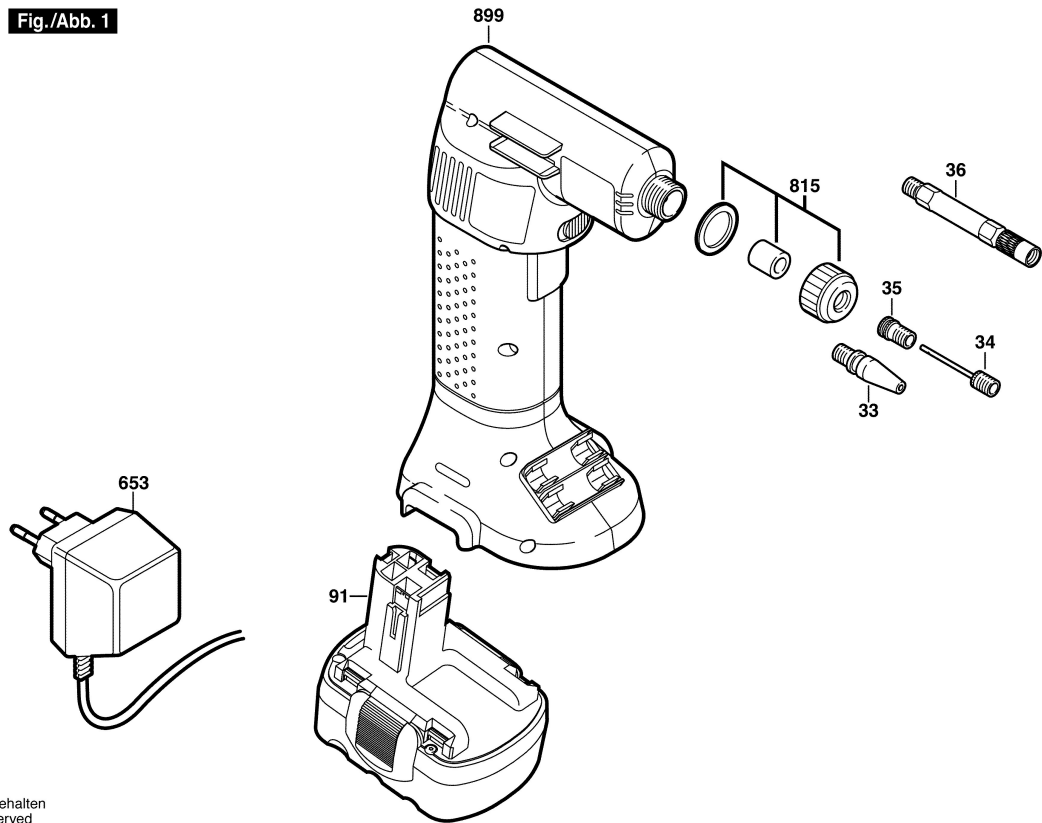

Änderungen vorbehalten
Modifications reserved
Modifications reserves
Salvo modificaciones