

0 607 261 105
 Issue } 05-02-28
 Stand }

Fig./Abb. 1

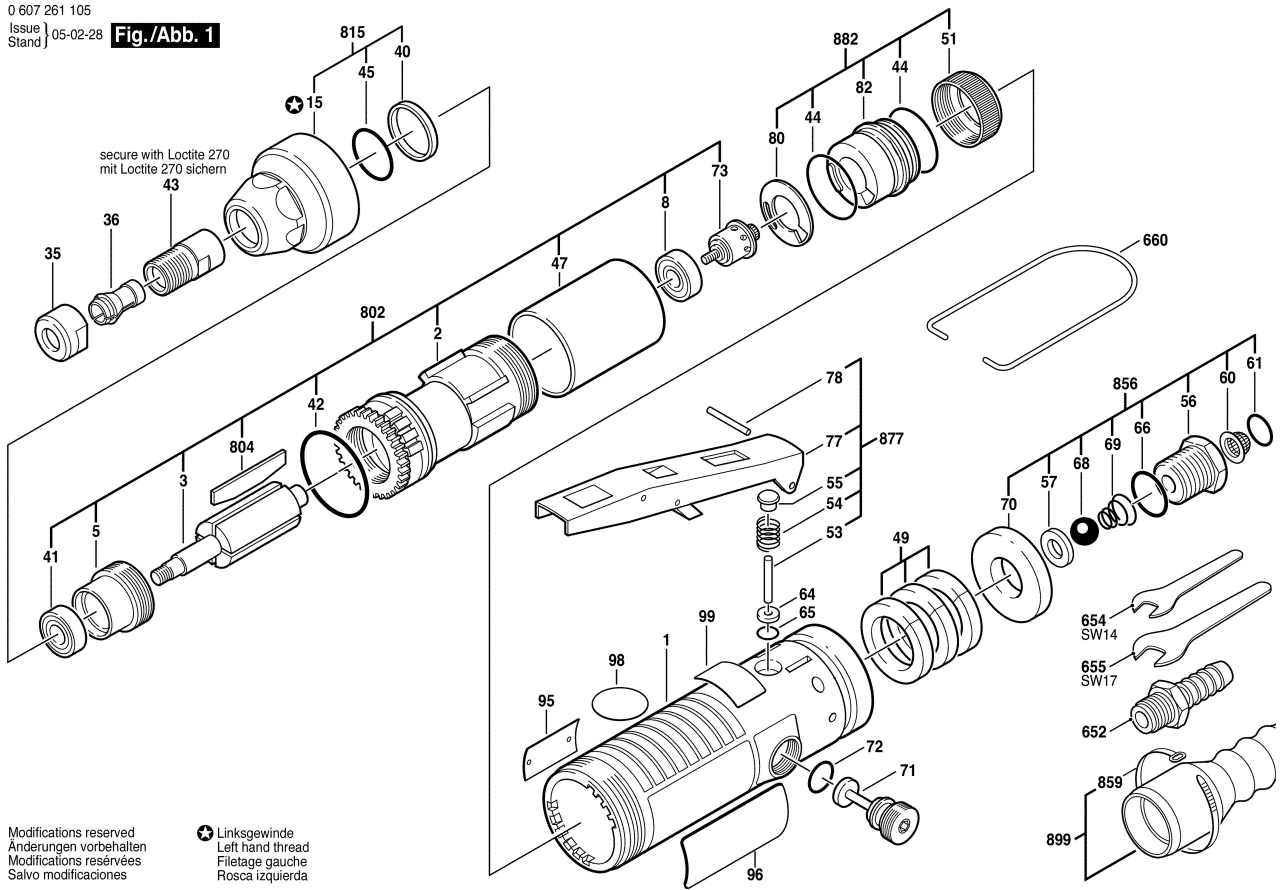

Modifications reserved
 Änderungen vorbehalten
 Modifications réservées
 Salvo modificaciones