

0 607 352 111; 113

Issue } 04-07-19 **Fig./Abb. 1**
Stand }

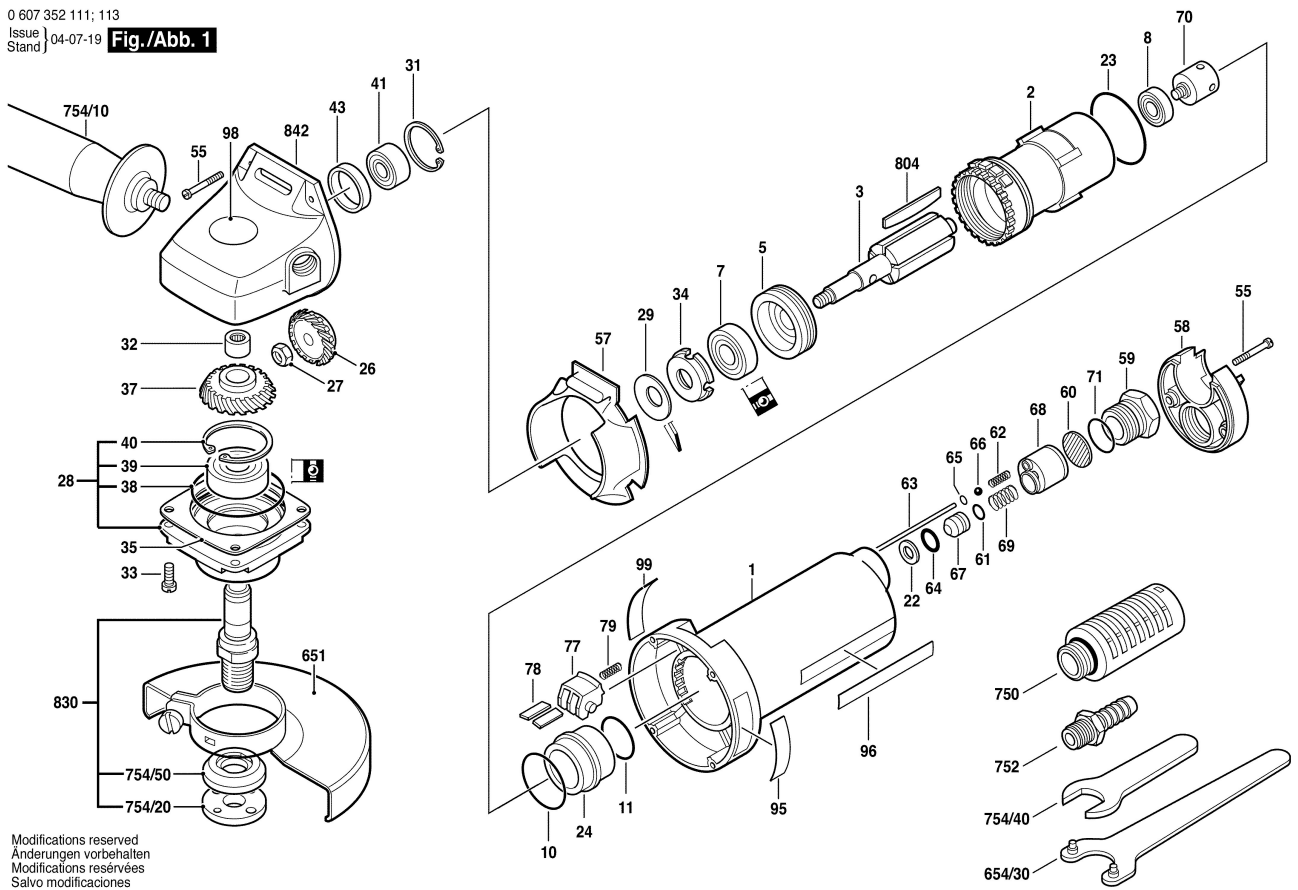

Modifications reserved
Änderungen vorbehalten
Modifications réservées
Salvo modificaciones