

3 601 D45 100
 Issue 14-04-23
 Stand

Fig./Abb. 1

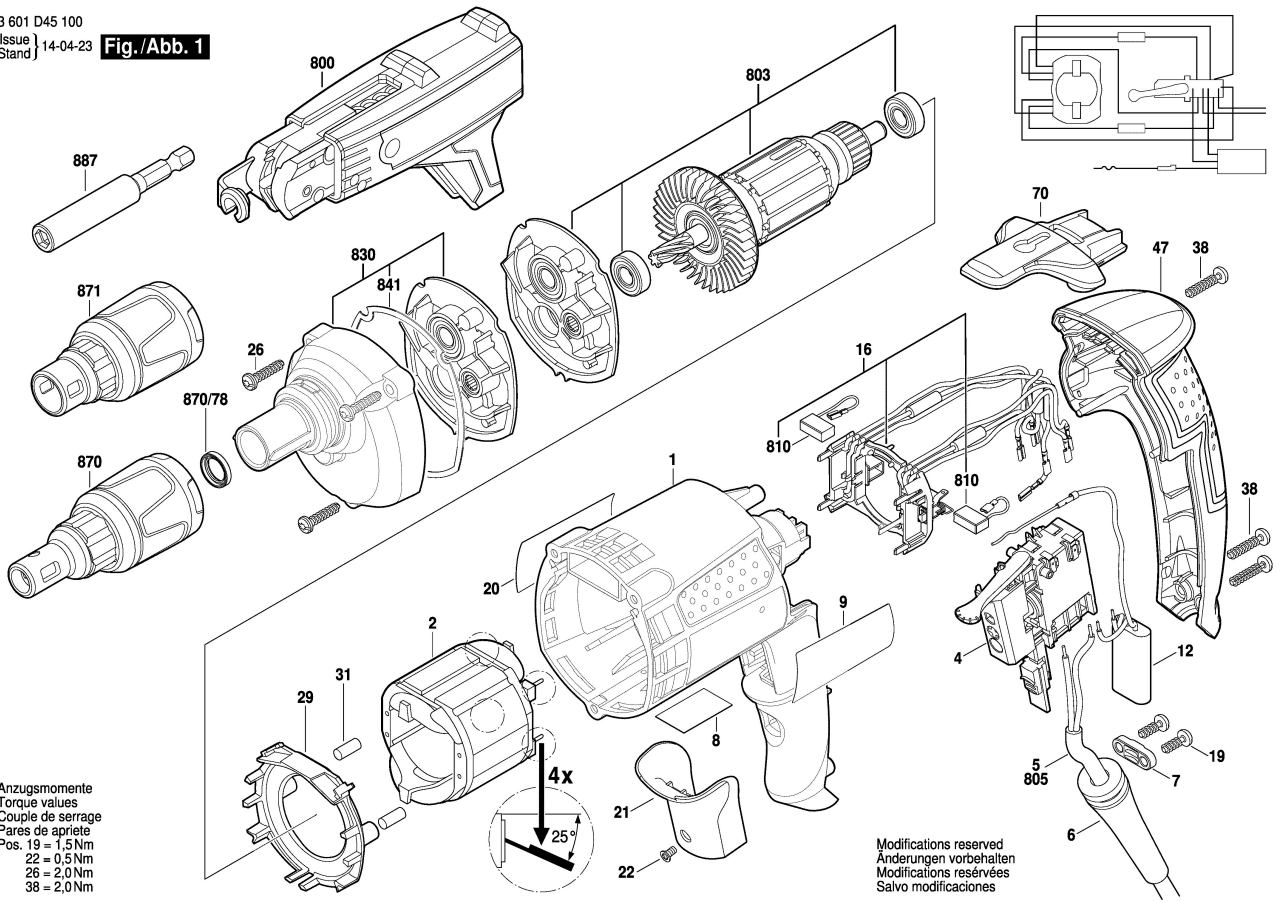

Anzugsmomente
 Torque values
 Couple de serrage
 Pares de apriete
 Pos. 19 = 1,5 Nm
 22 = 0,5 Nm
 26 = 2,0 Nm
 38 = 2,0 Nm

Modifications reserved
 Änderungen vorbehalten
 Modifications réservées
 Salvo modificaciones