

3 601 D45 100  
 Issue 14-04-23  
 Stand

**Fig./Abb. 1**

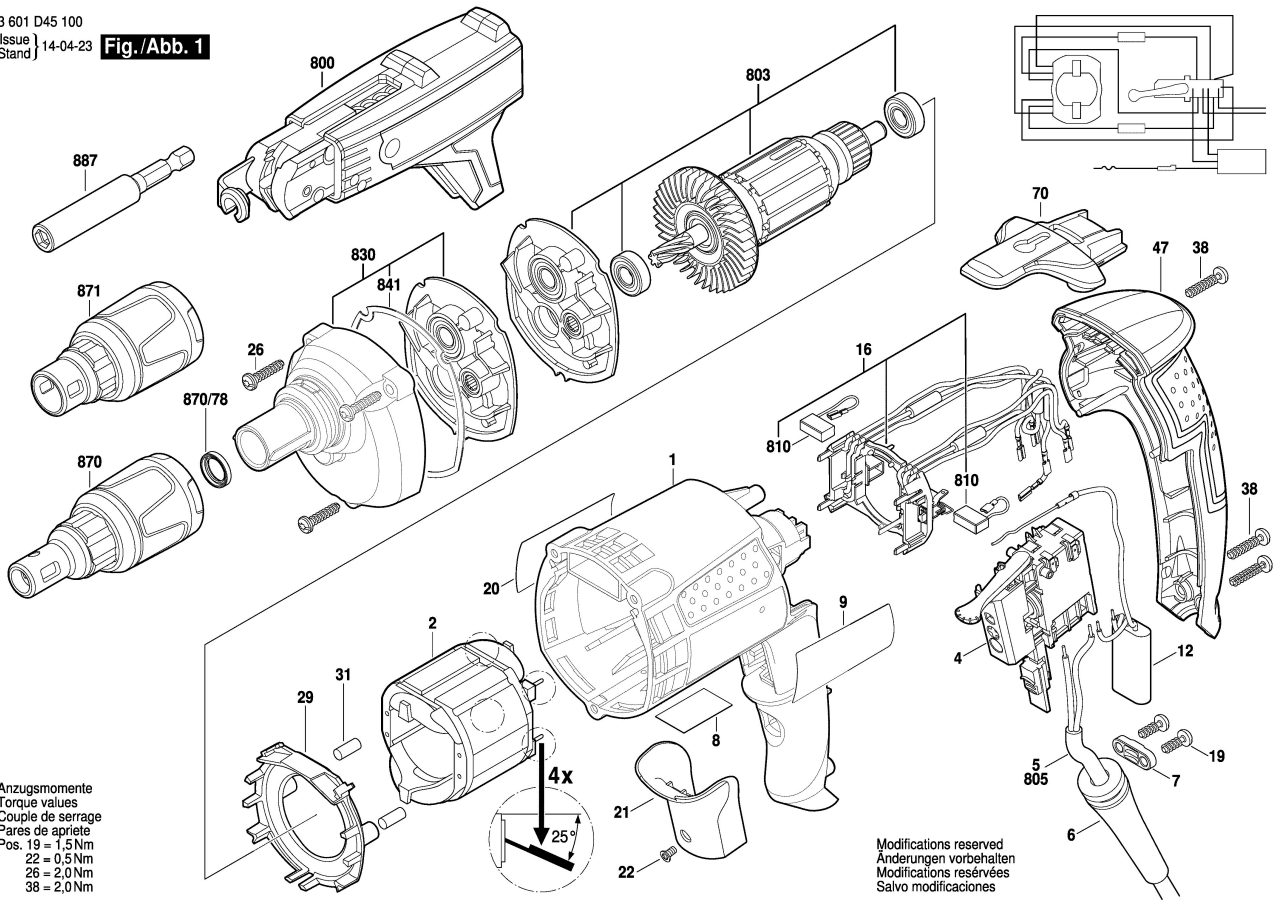

Anzugsmomente  
 Torque values  
 Couple de serrage  
 Pares de apriete  
 Pos. 19 = 1,5 Nm  
 22 = 0,5 Nm  
 26 = 2,0 Nm  
 38 = 2,0 Nm

Modifications reserved  
 Änderungen vorbehalten  
 Modifications réservées  
 Salvo modificaciones