

3 601 D73 580

Stand 1 09-09
Issue J 09-11-06

Fig./Abb. 1

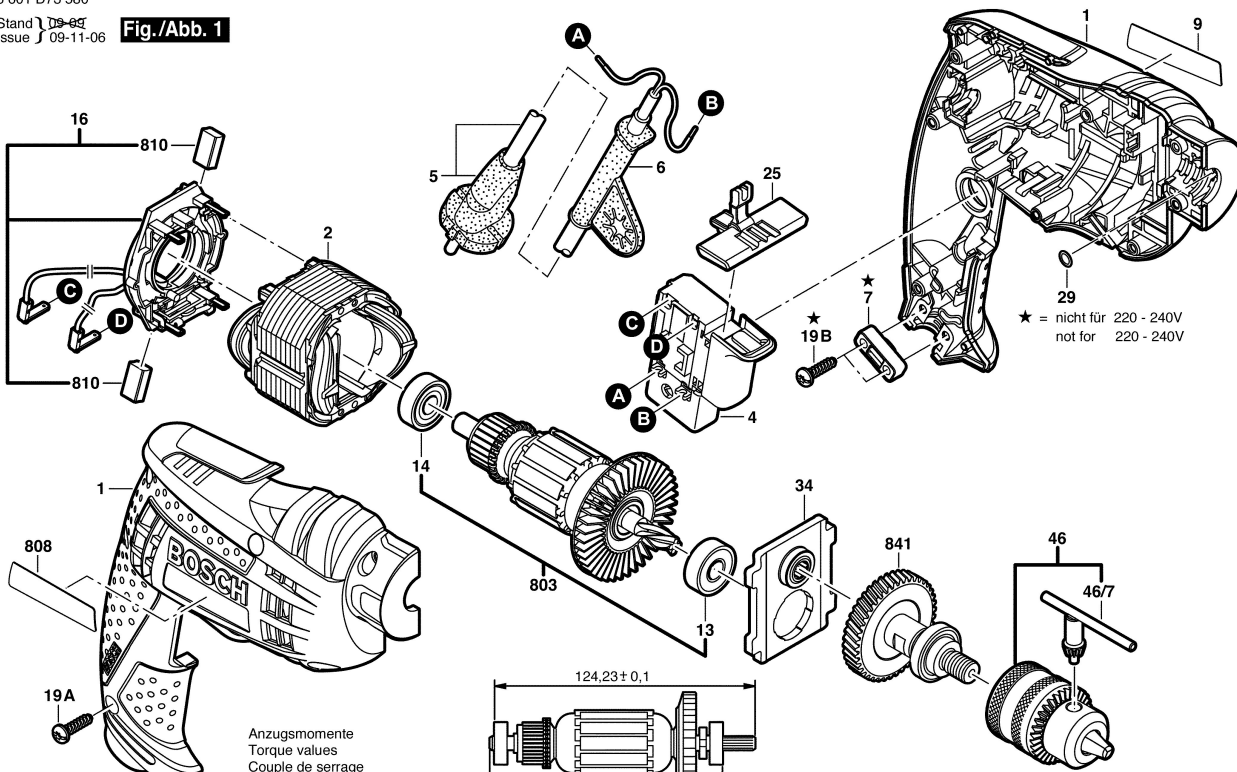

Änderungen vorbehalten
Modifications reserved
Modifications reserves
Salvo modificaciones

Anzugsmomente
Torque values
Couple de serrage
Pares de apriete
Pos. 19A (8x) = 1,6 - 2,4 Nm
19B (2x) = 1,8 - 2,2 Nm

