

3 601 H61 T00

Stand 10-02-03  
Issue 10-02-03

**Fig./Abb. 1**

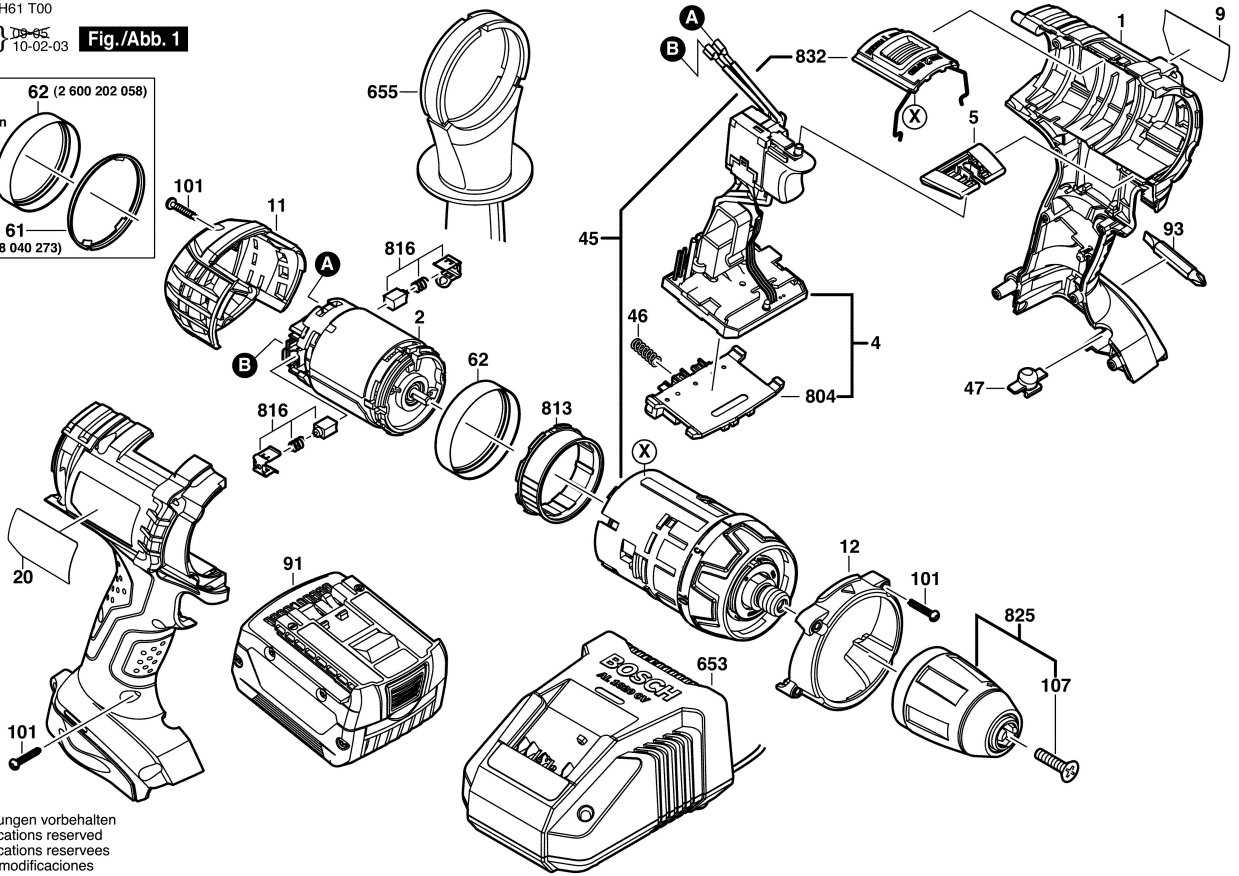
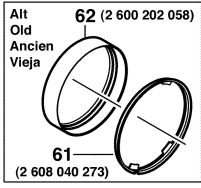

Änderungen vorbehalten  
Modifications reserved  
Modifications reserves  
Salvo modificaciones