

3 601 J94 401

Stand 10-01
Issue 10-02-03

Fig./Abb. 1

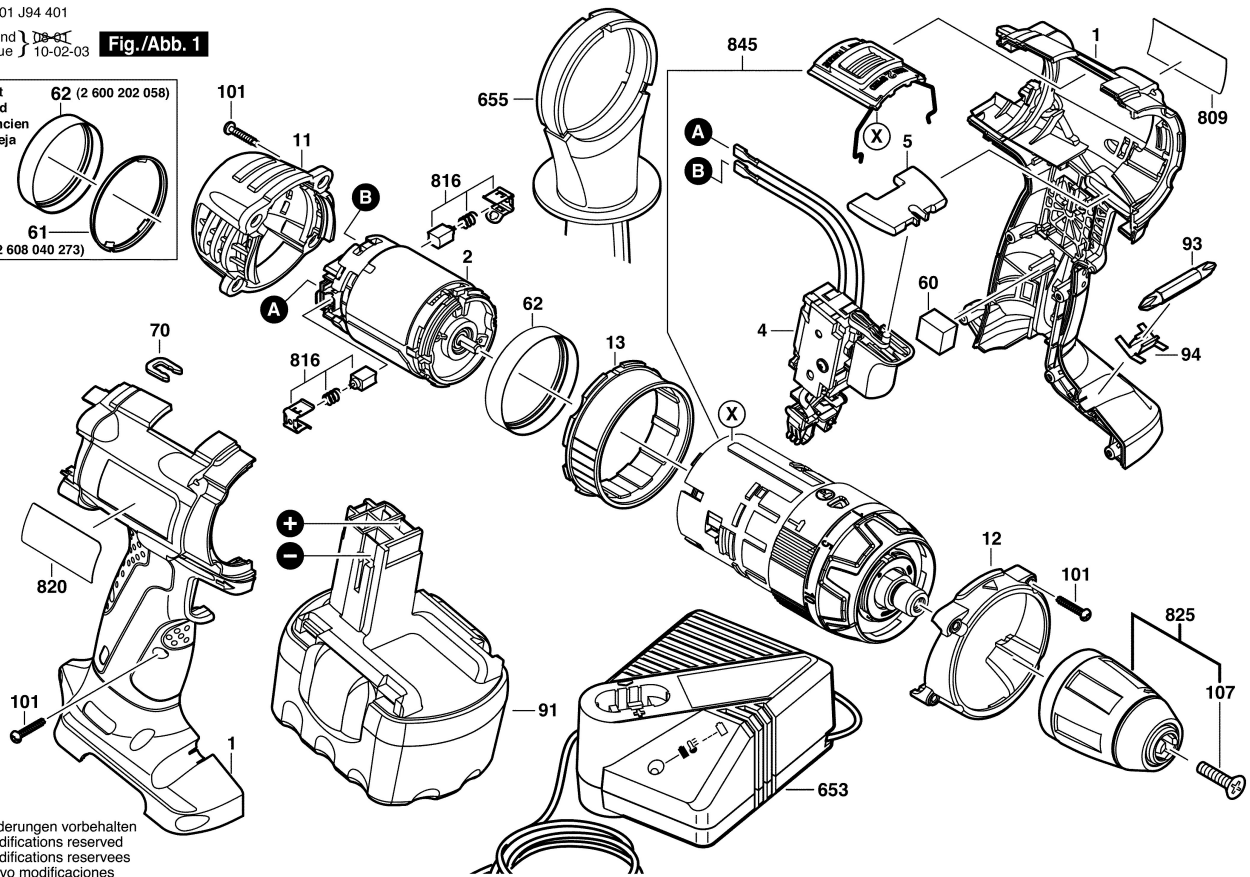
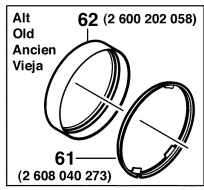

Änderungen vorbehalten
Modifications reserved
Modifications reserves
Salvo modificaciones