

3 601 JA5 400  
 Stand 109-12  
 Issue J 10-01-29

**Fig./Abb. 1**

Anzugsmomente  
 Torque values  
 Couple de serrage  
 Pares de apriete  
 Pos 40 = 0,5- 0,8 Nm  
 101 = 0,8- 1,0 Nm  
 105 = 1,7- 2,0 Nm  
 107 = 4,0 5,0 Nm

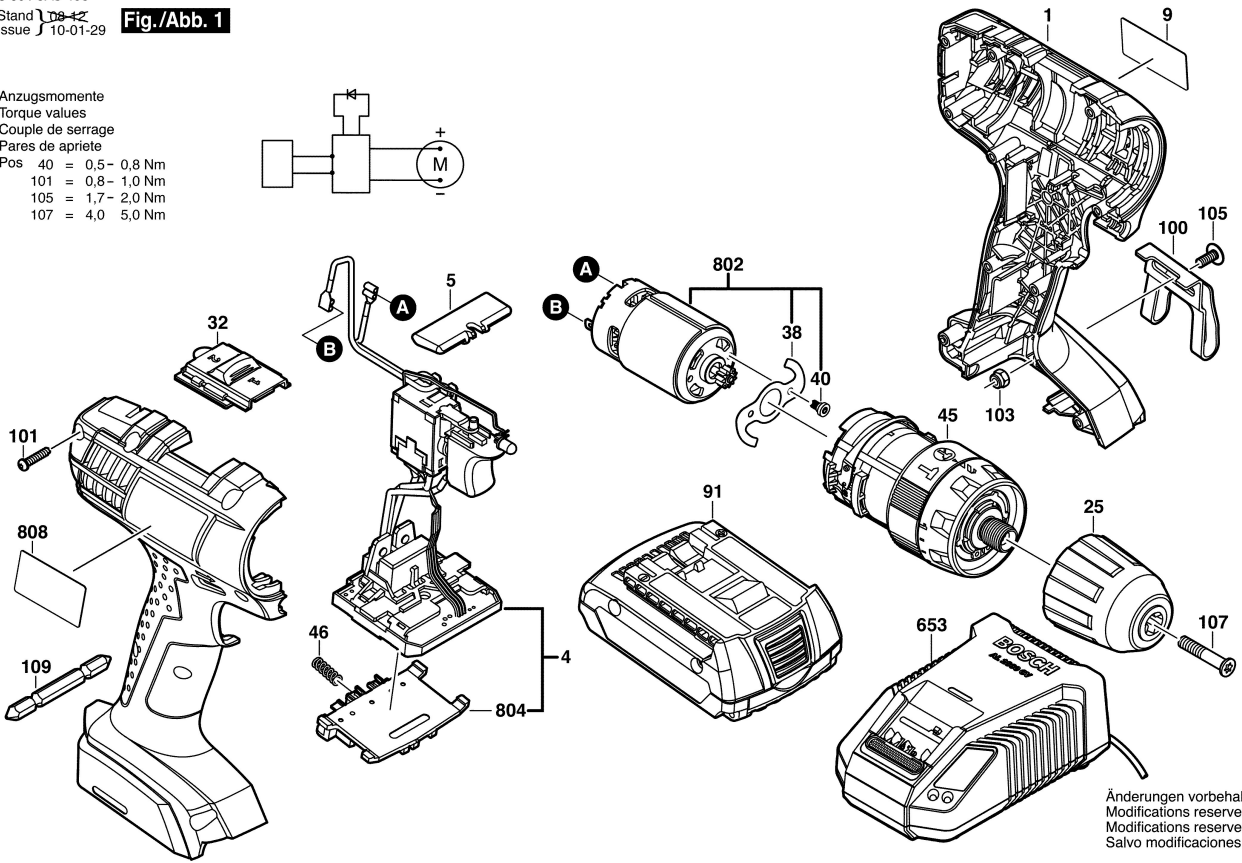

Änderungen vorbehalten  
 Modifications reserved  
 Modifications reserves  
 Salvo modificaciones