

3 601 JD4 080
 Stand | 13-09
 Issue | 13-10-09

Fig./Abb. 1

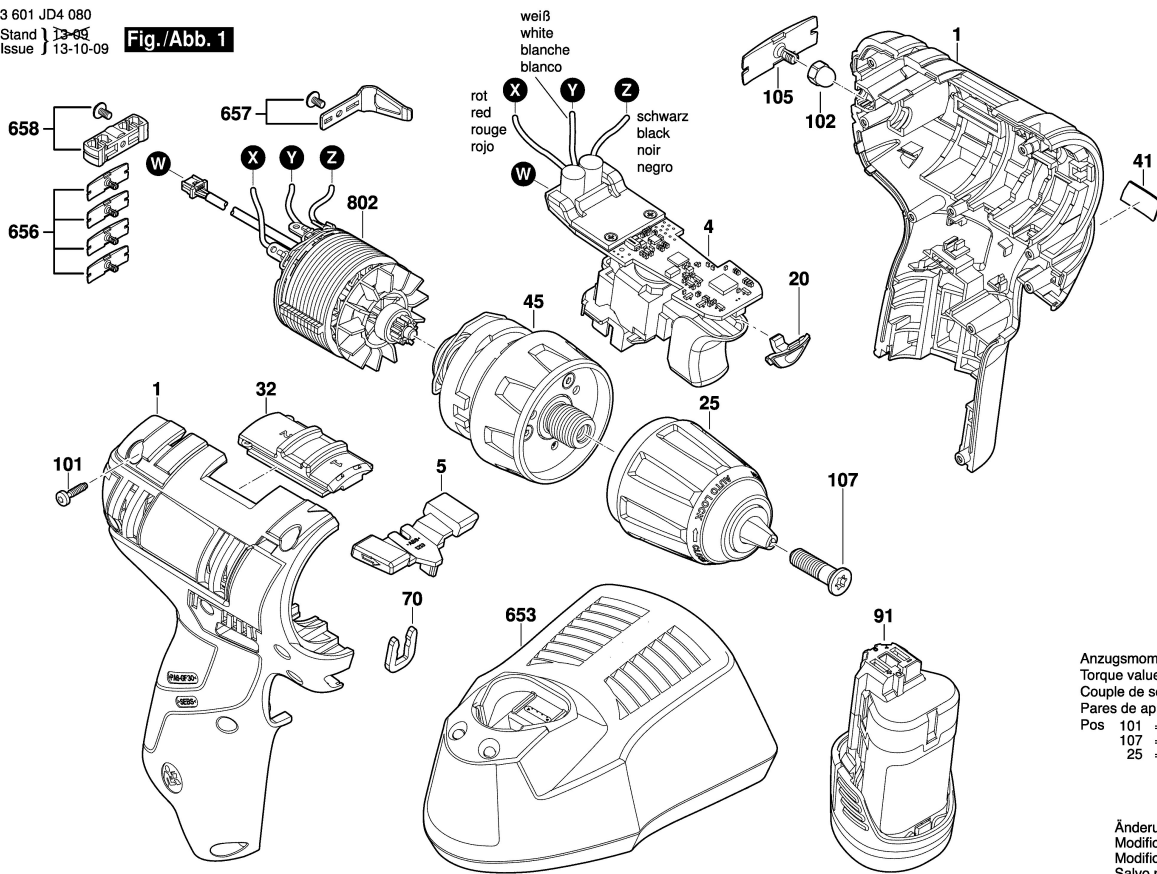

Anzugsmomente
 Torque values
 Couple de serrage
 Pares de apriete
 Pos 101 = 0,4 - 0,6 Nm
 107 = 5,0 - 8,0 Nm
 25 = > 15,0 Nm

Änderungen vorbehalten
 Modifications reserved
 Modifications reserves
 Salvo modificaciones