

3 602 D94 601; 600

Issue } 14-08-07 **Fig./Abb. S**

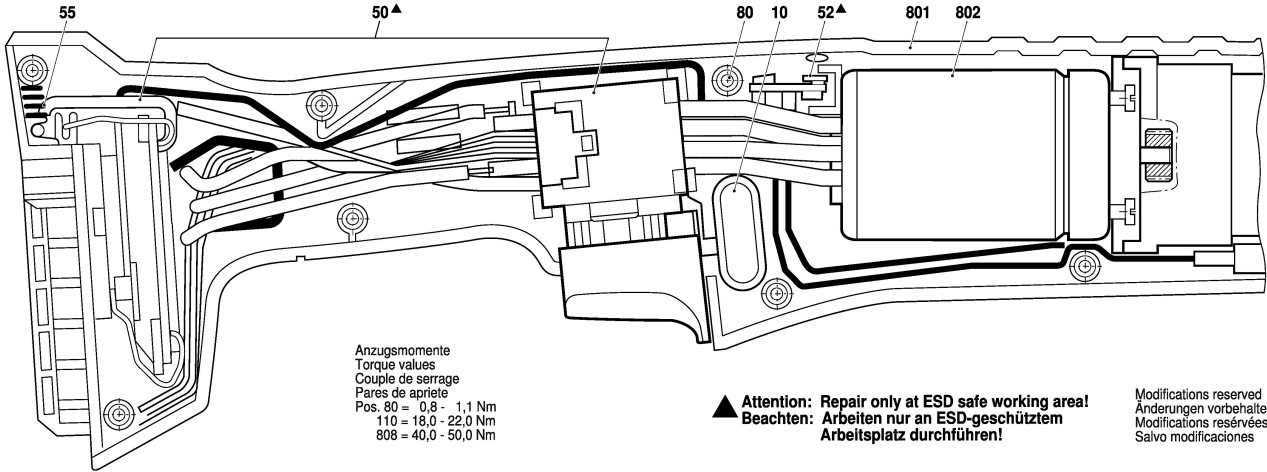
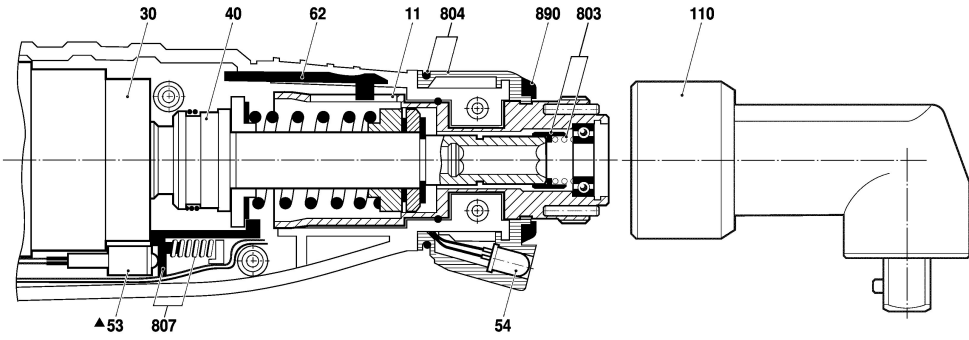

Anzugsmomente
Torque values
Couple de serrage
Pares de apriete
Pos. 80 = 0,8 - 1,1 Nm
110 = 18,0 - 22,0 Nm
808 = 40,0 - 50,0 Nm

▲ Attention: Repair only at ESD safe working area!
Beachten: Arbeiten nur an ESD-geschütztem Arbeitsplatz durchführen!

Modifications reserved
Änderungen vorbehalten
Modifications réservées
Salvo modificaciones