

3 603 J56 400

Stand 06-09-20  
Issue

**Fig./Abb. 1**

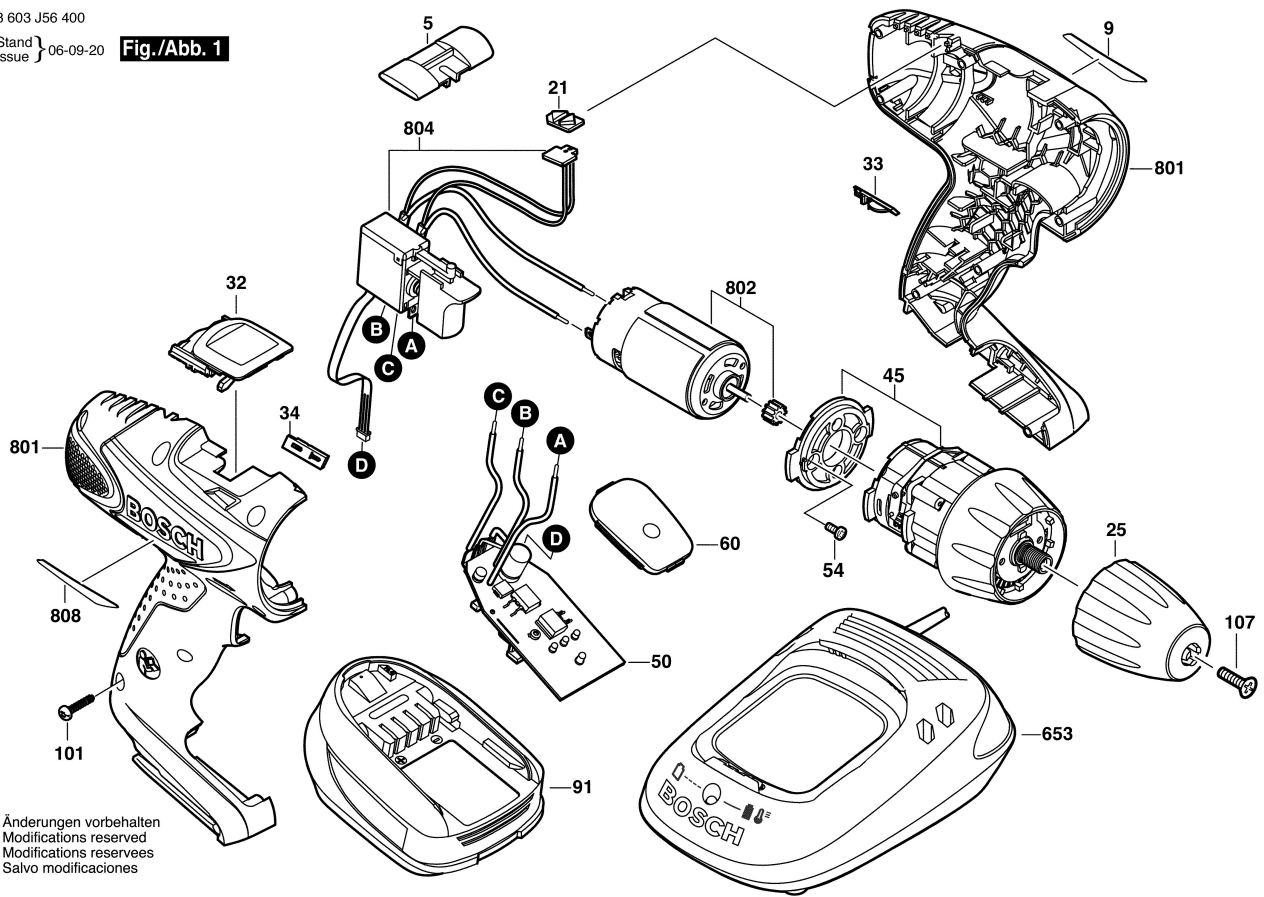

Änderungen vorbehalten  
Modifications reserved  
Modifications reserves  
Salvo modificaciones