

3 603 J56 400

Stand 06-09-20
Issue

Fig./Abb. 1

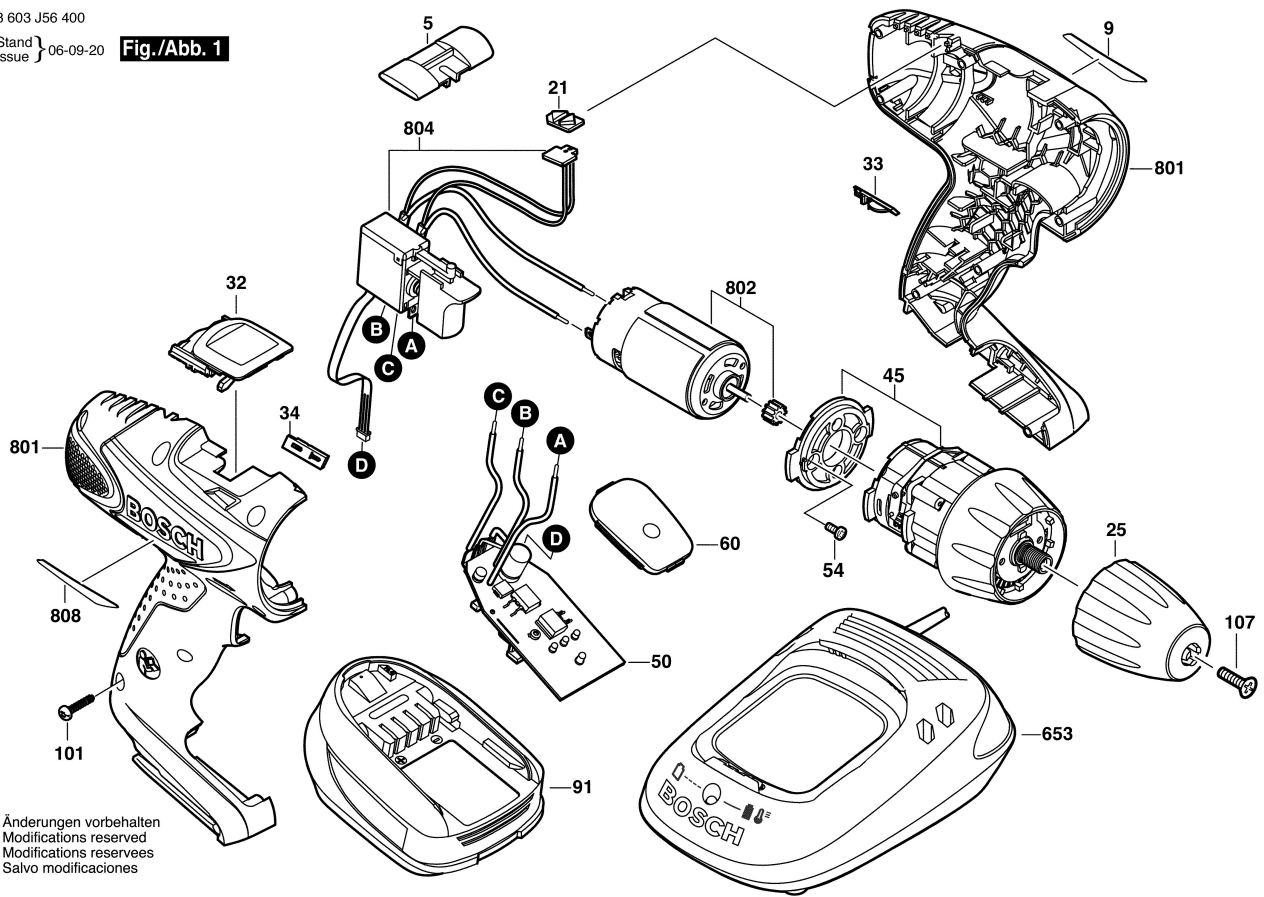

Änderungen vorbehalten
Modifications reserved
Modifications reserves
Salvo modificaciones