

**Type:** FMM 350 Q (50/60Hz, 110/120V)  
**Part no.:** 72294231110

7 229 42 - FMM 350Q

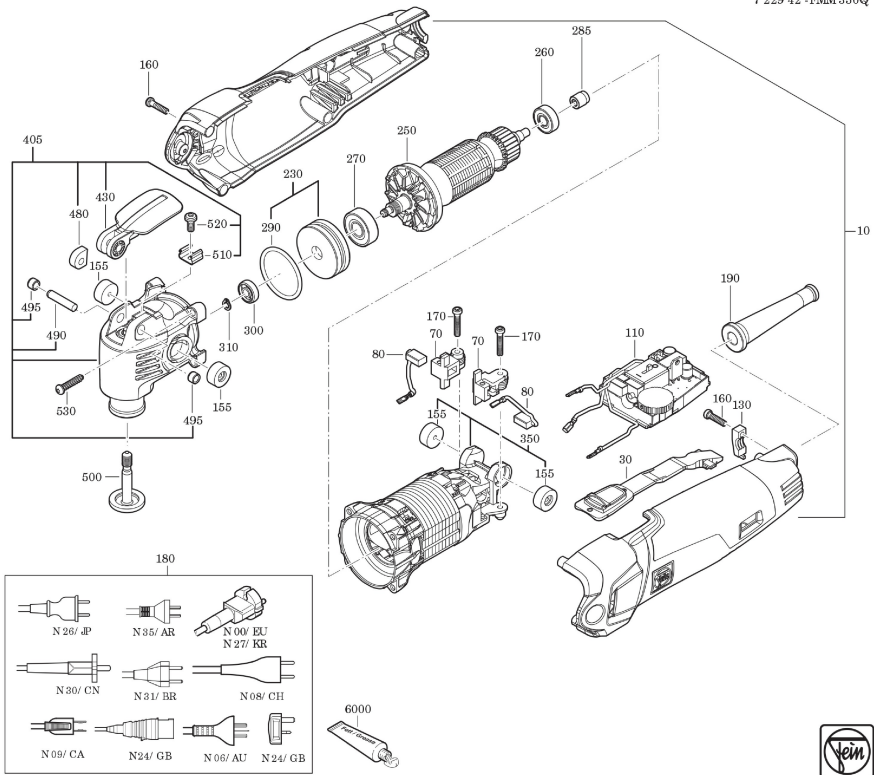

**Type:** FMM 350 Q (50/60Hz, 110/120V)  
**Part no.:** 72294231110

7 229 42 - FMM 350Q

