

F 013 810 000

Stand } 12-10-05 **Fig./Abb. 1**

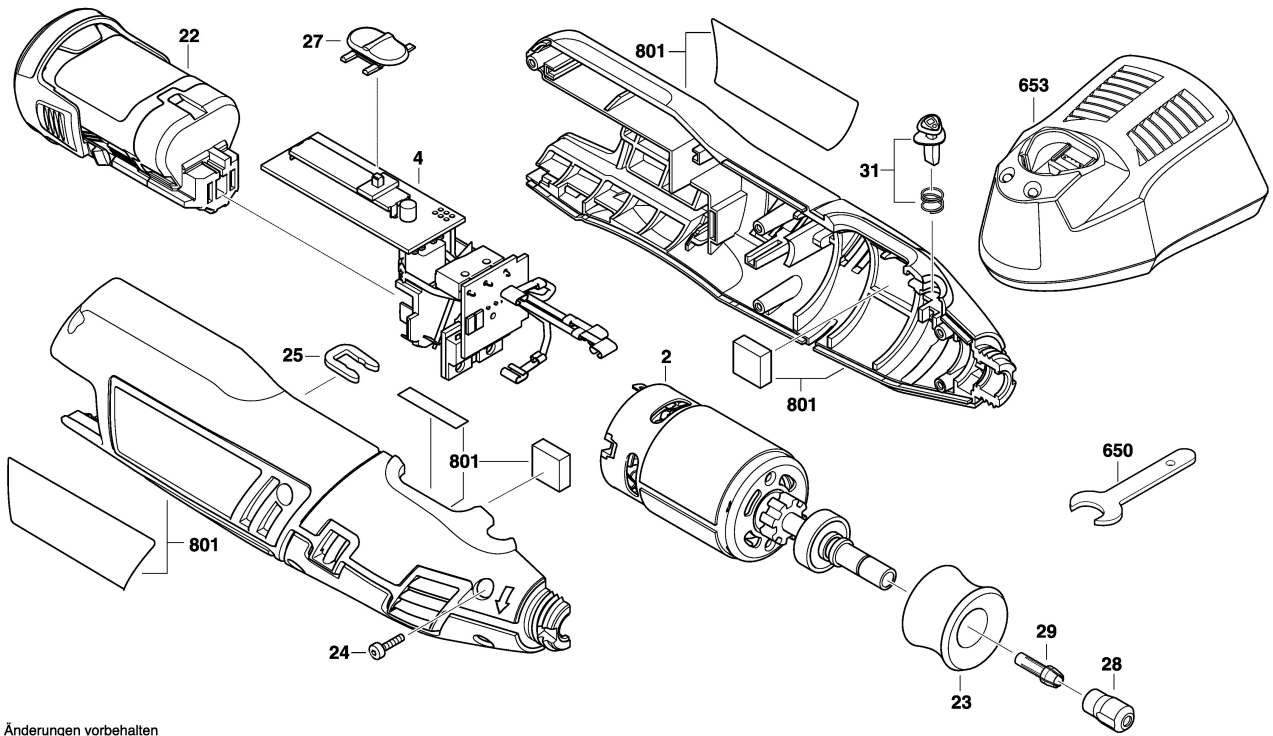

Änderungen vorbehalten  
Modifications reserved  
Modifications réservées  
Salvo modificaciones