

F 015 637 001

Stand Issue 04-10-20 **Abb./Fig. 1**

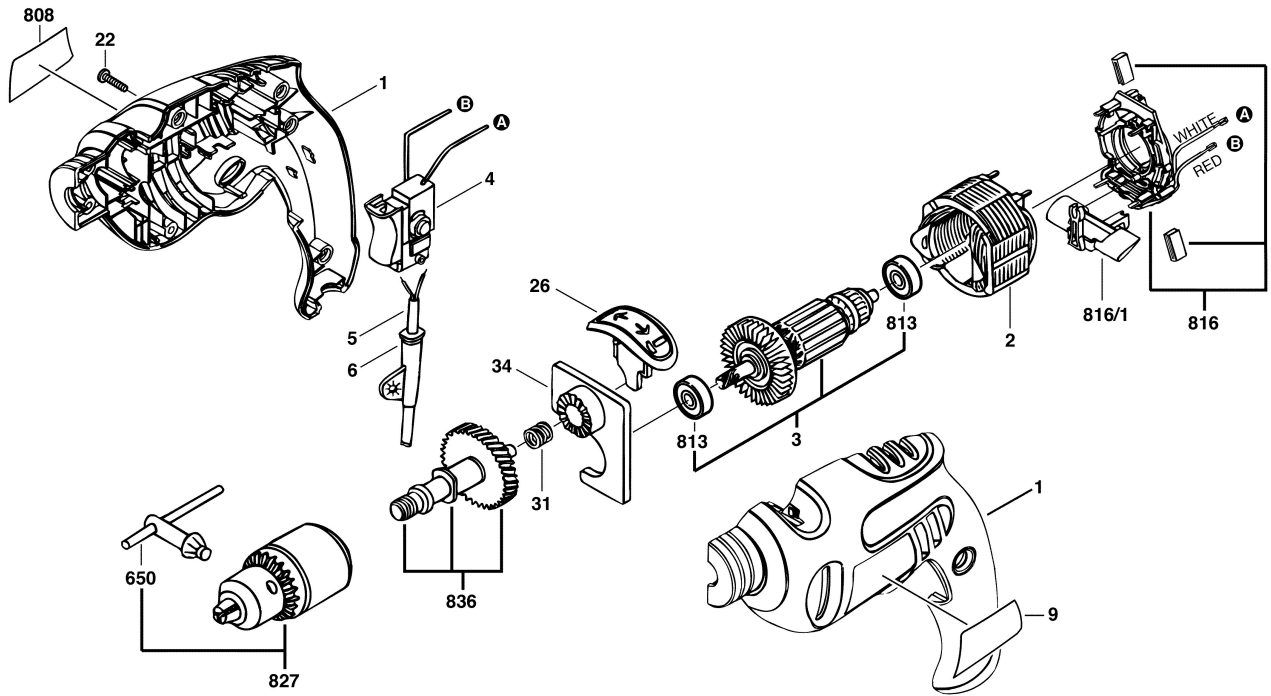

Änderungen vorbehalten
Modifications reserved
Modifications reserves
Salvo modificaciones