

F 015 661 624  
Issue }  
Stand } 13-06-26

Fig./Abb. 1

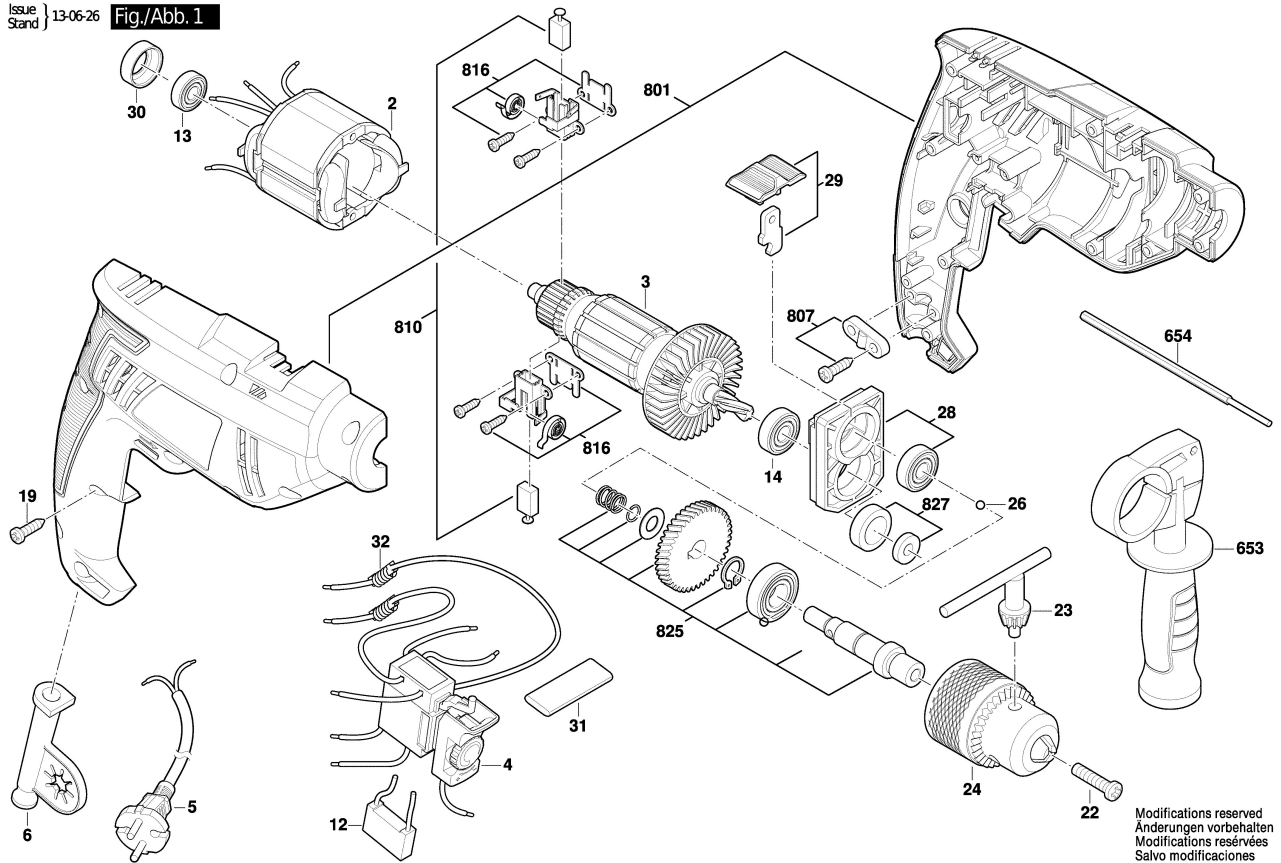

Modifications reserved  
Änderungen vorbehalten  
Modifications réservées  
Salvo modificaciones