

WARNING! Electrical repairs should be attempted only by trained repairmen. Contact the nearest SKIL Service Center or other competent repair service.

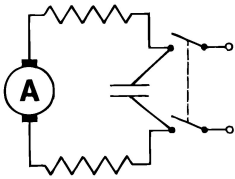

WIRING DIAGRAM

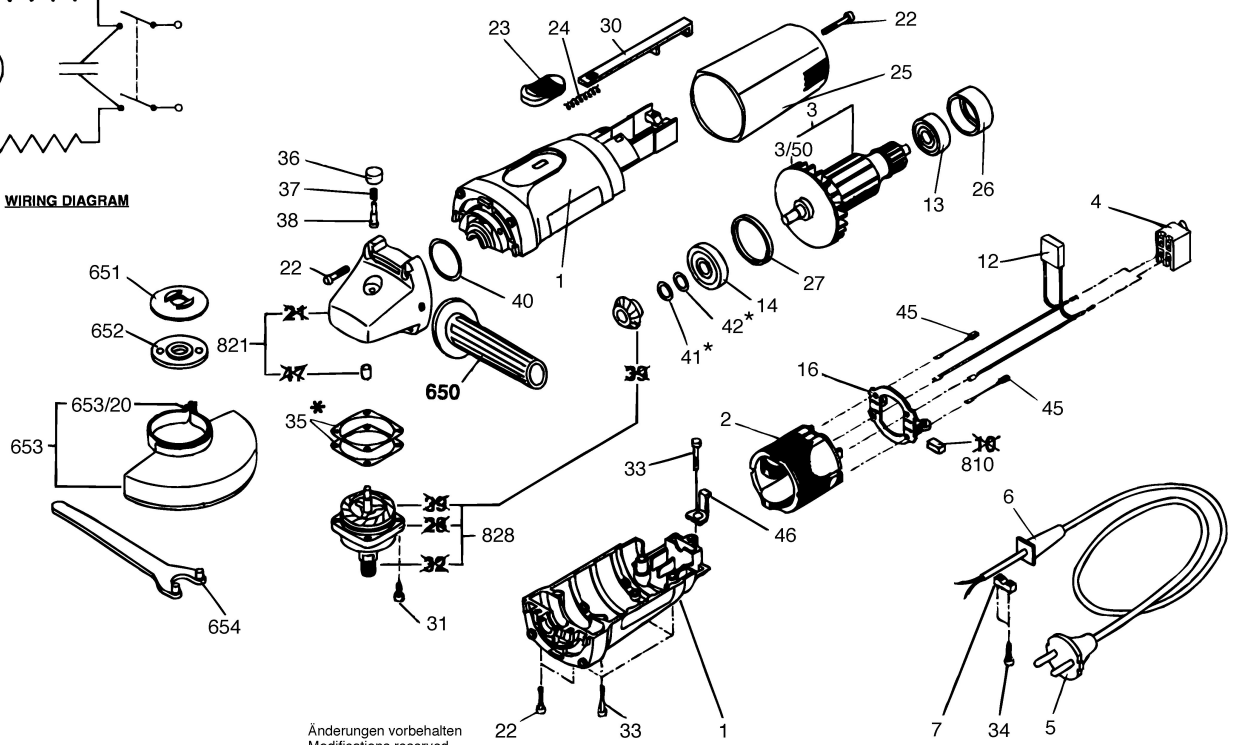

Änderungen vorbehalten
 Modifications reserved
 Modifications reserves
 Salvo modificaciones

F0159115F3