

0 600 829 103

Stand 00-09-12
Issue 00-09-21

Fig./Abb. 1

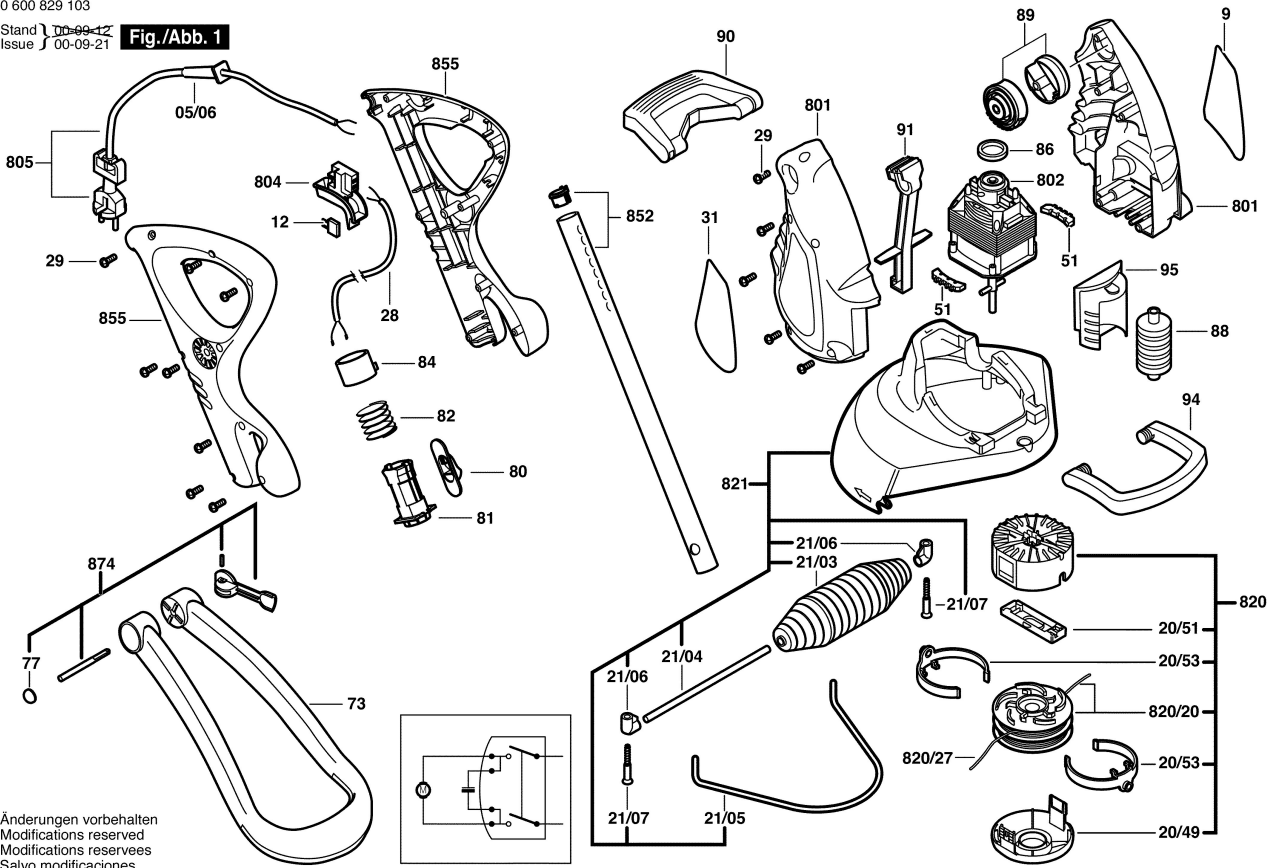

Änderungen vorbehalten
Modifications reserved
Modifications reserves
Salvo modificaciones