

0 600 873 003
Stand | 08-01
Issue | 11-11-18

Fig. /Abb. 3

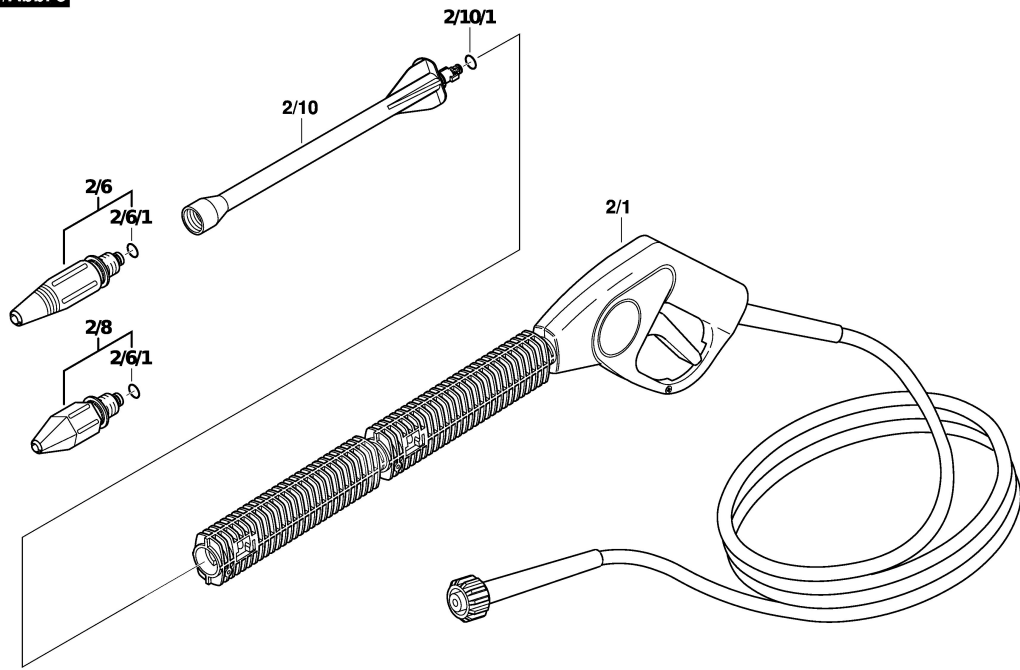

Änderungen vorbehalten
Modifications reserved
Modifications reserves
Salvo modificaciones