

0 600 847 077
Stand 05-14
Issue 09-02-05

Fig./Abb. 1

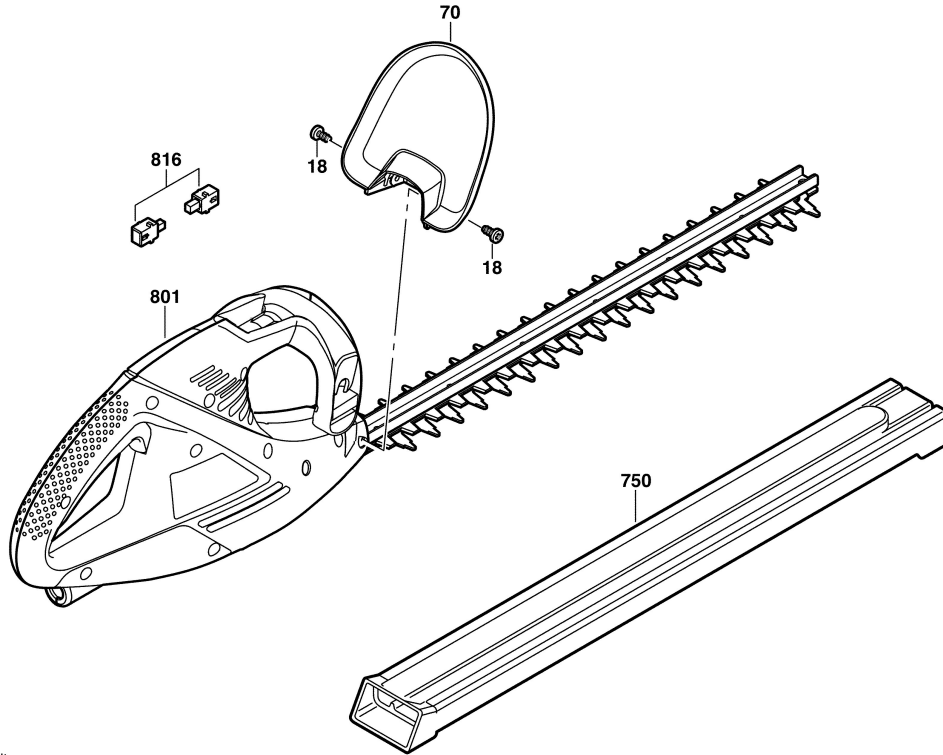

Änderungen vorbehalten
Modifications reserved
Modifications réservées
Salvo modificaciones