

0 601 098 180

Stand } 00-09-14
Issue }

Fig./Abb. 1

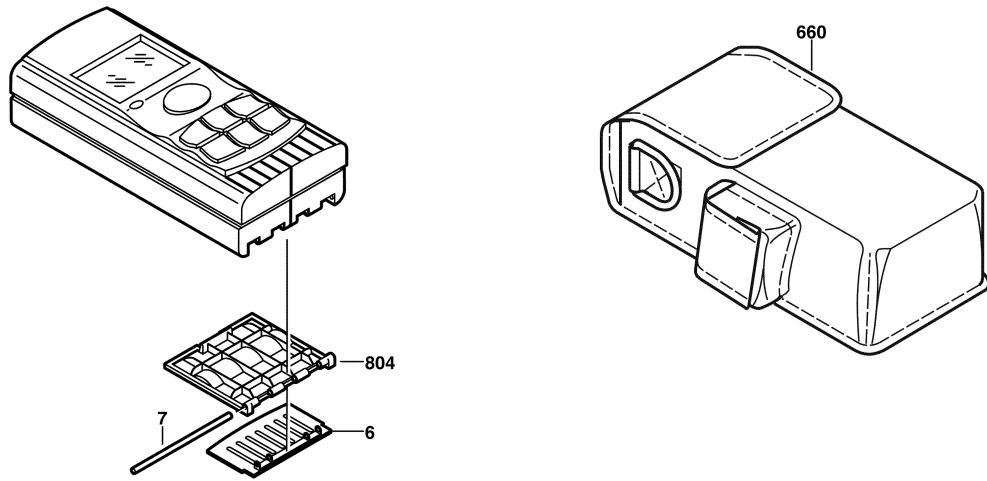

Änderungen vorbehalten
Modifications reserved
Modifications reserves
Salvo modificaciones